



# PROCEEDINGS

## 2016 ASIAN ALUMNI WORKSHOP ON RESILIENCE IN ENERGY SYSTEM

Association of Indonesia Alumni of University of Flensburg  
in collaboration with  
Europa Universität Flensburg

Jakarta – Indonesia, 20 June 2016

## Foreword

**Prof. Dr. Bernd Möller, head of the EEM programme at the University of Flensburg, Germany**

The present book of proceedings from the Asian Alumni workshop on May 16-20 in Bandung, Indonesia, summarizes the significant input of participating alumni of German universities. Thanks to the great effort of the organizing Alumni from the SESAM/EEM program of the University of Flensburg, a large variety of contributions was collected and processed into this book. What lies between the call for abstracts in February 2016 and the present publication is the enormous body of work put into organizing and managing the conference with thirty-seven participants in Bandung.

Every Alumni event of the SESAM/EEM program is like a family gathering, where former students of this program and their colleagues from other DAAD-funded studies in Germany meet. The format is that of a scientific conference, where Alumni present their current work and discussions are highly encouraged in the sessions and in the breaks in-between.

The selection of papers presented documents that Asia, being the World's focal point of economic development, also is a continent where solutions to problems associated with growth, energy use and the environment are being developed. The invited professionals from governments, industry, research and non-governmental organizations have shared their significant experience during the conference, and bring home the lessons collectively learned.

The theme of the alumni workshop was "Resilient energy systems", understanding resilience as the ability to cope with dramatic change. Two main areas that experience substantial change these years are the fast economic development in many countries as well as the changes to ecosystems. Resilient energy systems will have to cope with issues resulting from these changes, like increased inequality, increased vulnerability to climate change, and a large number of associated challenges.

Specifically, the workshop has been divided into seven topic areas, six of them addressing subjects like energy planning, energy system resilience, renewable energy, entrepreneurship, energy efficiency and education. The seventh topic addressed the continuation and further development of alumni networking. In the present book of proceedings the reader will find the papers presented at the alumni conference, as a documentation of the enormous work effort behind, and as an inspiration for making new contacts and seeking new forms of collaboration.

It is through alumni conferences like this that a "life-long learning" relationship between a university program and its former graduates can be maintained. Past workshops and this one in Bandung offer great opportunities for alumni to keep up to date, to network, and to share feed-back with their Alma Mater on the basis of professional careers and the experiences from the real world.

**Susy M. Simarangkir, Head of Committee**

Dear Authors, esteemed Readers,

The Association of Indonesian Alumni of University of Flensburg was established in 2015 as a response to the 25th Anniversary of University of Flensburg to organizing a workshop on Resilient Energy System. Eighteen Indonesian alumni are now working in various sectors, such as government institutions, NGO, oil and gas company, international agency, consultant and others and in a prominent position.

We bring up Resilient Energy System as the theme of the workshop because the challenge of providing reliable and affordable energy to fulfill the growing demand becomes stringent, not only in developing country but around the globe, more severe due to the climate change. The climate is progressively changing creating new challenges for energy systems including energy supply and demand. Resilience in energy systems implies to a system that can ensure secure balance between energy supply and demand despite internal and external development such as climate change. The options in mitigation and adaption can alleviate the climate change impact but no single option can be successful by itself.

Energy planning and policy, business and entrepreneurship models, renewable energy, energy efficiency, energy systems and education in environment are the chosen areas to be shared and discussed in the workshop. Thirty-seven participants from 7 Asian countries and 1 European country shared their knowledge and ideas taken from their in-depth experiences on the selected topic and this Proceeding is the compilation of papers written by participants.

The workshop also would like also to develop and strengthen the bond among German alumni. We believe we all can do better when we work together and it is unsurprisingly one solution in one country may be implemented successfully in other country. I trust also that this will be an impetus to stimulate further study and research in all these areas.

We thank all authors for their contributions.

## Table of Contents

Foreword .....	2
CHAPTER 1. ENERGY PLANNING AND POLICY FOR RESILIENT ENERGY SYSTEM.....	6
Renewable Energy Development Strategy in Indonesia .....	7
The key to regional energy planning towards a 100% renewable electricity system for ASEAN.....	13
Energy Development in Supporting Sustainable Development in Indonesia .....	23
CHAPTER 2. ENERGY SYSTEM RESILIENCE TO ECONOMIC DYNAMICS AND CLIMATE CHANGE.....	33
Energy System Resilience to Economic Dynamic and Climate Change (Focusing on Local Adaption Plan for Action of Nepal) .....	34
Towards a Framework for Resilient Monitoring & Control Systems Design: An Application in Network of Power Systems.....	39
Cross Border Energy Cooperation: A structural energy security approach in Asia addressing SDG .....	46
CHAPTER 3. RENEWABLE ENERGY .....	67
Solar powered safe drinking water supply schemes for climate vulnerable and salinity affected off-grid coastal people .....	68
Solar Power Based Mgiri Technologies for Agriculture and Agroprocessing Industries And Its Impacts.....	79
Powering Agriculture Waste for Sustainable Power Generation in Indonesia.....	87
Biogas Development in Nepal: Experiences from the Private Sectors .....	94
Design of Renewable Energy Data Measurement Instrument for Archipelago Area.....	102
Utilization of Jaboi Geothermal Resources by Using Binary Cycle Power Plant.....	109
Purification of Bioethanol as Biofuel with Nanozeolite.....	120
CHAPTER 4. BUSINESS AND ENTREPRENEURSHIP MODELS FOR RESILIENT AND SUSTAINABLE ENERGY SYSTEMS.....	128
The Application of Balanced Scorecard In Business Canvas Model To Link The Sustainable Energy to Enterprise Strategies.....	129
Strategic Marketing Plan of LED Lamps towards Resilient Energy Systems.....	139
IDCOL: An Organization for Financing Resilient and Sustainable Energy Systems .....	148
Accelerated Commercialization of Photovoltaic Water Pumping System in Nepal .....	156
CHAPTER 5. EDUCATION FOR ENVIRONMENTAL SUSTAINABILITY AND RESILIENCE .....	161
Promoting the Greening Curriculum .....	162
Model Community for Zero Waste Management by 3Rs.....	169

CHAPTER 6. ENERGY EFFICIENCY IN INDUSTRY, HOUSEHOLD, TRANSPORTATION AND BUILDINGS .....	179
Application of Mini Compressors to Recover Gas Flaring .....	180
“Detailing the Renewable Energy and Energy Efficiency Indicators fo Improving the Energy Security Model of Indonesia? A Preliminary Research” .....	191
CHAPTER 7. ALUMNI NETWORK.....	200
Flensburg Association for Energy Management - Nepal (FAEM –Nepal): The Past, Present and Future.....	201

# **CHAPTER 1. ENERGY PLANNING AND POLICY FOR RESILIENT ENERGY SYSTEM**

# Renewable Energy Development Strategy in Indonesia

Prof. Dr.rer.pol. Ir. H.Didik Notosudjono, MSc<sup>1</sup>.

<sup>1</sup>Faculty of Engineering, Pakuan University of Bogor, West Java, Indonesia

E-mail: notosudjono@yahoo.com, didik@ristekdikti.go.id

## **Abstract**

*Keywords : Renewable Energy Potential; Renewable energy sources; Sustainable Development; Renewable energy targets and strategies*

In the framework of climate change, the use of renewable energy as a clean energy become a worldwide trend as it could potentially reduce greenhouse gas (GHG) emissions, as well as global warming from the conventional energy sources. In this case, Indonesia has a sizeable Potential Renewable Energy that is spread across various regions, where the primary advantage of using this renewable energy potential in Indonesia is the generally-low operating cost, by utilizing a sustainable local energy source, and the current regulatory support in the field of renewable energy is proved to be favourable. Therefore, supporting the development of Renewable Energy in Indonesia

The purpose of developing renewable energy is to achieve the goals and objectives of the renewable energy development as stated in RPJMN 2015-2019 (Portions of renewable energy amounting to 16% of final energy mix) mix to reach the target of 23% renewable energy by 2025 and 31% in 2050 from final energy mix in accordance with the Indonesia National energy Policy (Government Regulation No. 79 of 2014), and utilizing the role of renewable energy to support the achievement of Electrification ratio 96.6% and electricity consumption per capita 1200 kWh in 2019.

Methods used to achieve these ends are literatures study, analyzing the data based on renewable energy, also by providing solutions and advice in developing a renewable energy in Indonesia

According to survey, National electrical energy supply in 2014 amounted to 53.352 MW, consisting of Fossil energy amounted to 42 022 MW (79%), and renewable energy amounting to 11,330 MW (21%). The desired target in 2019 amounted to 96 320 MW with an explanation of energy Fossil amounted to 79 366 MW (82%) and renewable energy amounting to 16 954 MW (18%), so that the energy shortage of 42 968 MW.

Based on these data, the efforts to reach the target until 2019 is not a trivial matter, whereas by 2025 the supply of electrical energy national target of 115 MW with a share of renewable energy by 23%, with respect to the above strategy of renewable energy development in Indonesia is Strengthening the role of renewable energy in the energy mix: (1) incentives and the right price to encourage investment; (i) the use of various renewable energy and bio-energy for power generation, and (iii) the use of biofuels. As well as increasing accessibility:

the supply of electricity to the islands and isolated rural villages, including the village of fishermen if possible, with solar energy and other renewable energy. Harnessing the potential of water resources for hydroelectric power, among others: (i) incentives to accelerate the development of hydropower, which dispensation utilization of forest land for the construction of hydroelectric power, setting the price of electricity and the provision of land, (ii) simplification of regulations and licensing requirements document for hydropower and an increase in energy use efficiency in Indonesia.

## I. BACKGROUND

Energy management which includes the supply, utilization and enterprise must be implemented in a fair, sustainable, optimal, and integrated in order to provide added value to the economy of the nation and the Unitary Republic of Indonesia. Provision, utilization and energy business, which is conducted continuously in order to improve the welfare of the people in its implementation must be harmonious and balanced with environmental functions.

The government has adopted a program of 35,000 MW of electricity development is outlined in the National Medium Term Development Plan 2015-2019. Commitment to fulfill as many as 35 000 MW of electric power in 2019 has become a national strategic program which is also contained in the Electricity Supply Business Plan (RUPTL) PT PLN (State Electricity Company) from 2015 to 2024 and was approved by the Decree of the Minister of Energy and Mineral Resources (ESDM) No. 0074K / 21 / MEM / 2015

The total installed power generation capacity in Indonesia by the end of 2014 reached 53 065 MW, with the level of electrification ratio reached 84.35%. The level of consumption per capita in Indonesia is lowest in the ASEAN countries, which is about 865 kWh per capita. Hopefully, by the accelerated development of power plants, the level of consumption per capita increased to 1200 kWh per capita in 2019 (KESDM, 2014). The level of electricity consumption per capita could represent the level of economic growth and social welfare. Indonesia problemsfor implementation of the National Energy Policy include:

- Still dependency state revenue on the results of energy resources; overlapping regulatory and legal uncertainties and licensing, especially in the energy sector;
- Lack of integrated coordination between the energy sector with other sectors such as industry, trade and technology sectors;
- The ambiguity of authority the central government and local government in terms of energy management resulted in frequent delays in the implementation of energy policy;
- The high subsidies on fossil energy prices so the policy development of new and renewable energy becomes obstructed because of competition with the price of fossil energy;
- The energy sector requires considerable investment costs, so that the necessary financial support mainly from the banking sector in supporting the policy in the energy sector;
- The energy source lies mostly less accessible locations is difficult, is in the forest conservation area and is located in the area of energy consumption is still low.
- National capacity to mastery of EBT technology is still limited, so it is still largely dependent on the technology developed countries.



- Energy prices are not based on economic value and increasing energy subsidies.

## II. OBJECTIVE

The purpose of the development of renewable energy is to achieve the goals and objectives of the renewable energy development in the Medium-Term Development Plan 2015-2019 (Portions of renewable energy amounting to 16% of final energy mix) and achieve the target mix of 23% renewable energy by 2025 and 31% in 2050 of the final energy mix in accordance with the National energy Policy (Government Regulation No. 79 of 2014), and utilizing the role of renewable energy to support the achievement of Electrification ratio 96.6% and electricity consumption per capita was 1200 kWh in 2019

## III. METHODS

The methods used to achieve the above objectives are:

- Observation method uses primary data and secondary data from existing energy plant in Indonesia, especially new and renewable energy.
- Analyze the potential of renewable energy in Indonesia and optimizing utilization to reach the target of 23% by 2015 and 31% in 2050, this is in accordance with Indonesia National energy development policy
- Make Renewable energy development strategy in Indonesia

## IV. RESULTS

National electrification ratio in 2014 is estimated to be 84.35% (source: DJK-EMR). According RUPTL PT PLN 2015-2024, 2015-2019 years of electricity development program includes the development of power plants, transmission lines and substation and distribution network. The development is to meet the economic growth of 6.7%, 8.8% growth in electricity demand and to achieve electrification ratio of 97% by 2019. This program is part of the development plan the next 10 years of electricity, including electricity generation program, while 35000 MW Potential and utilization of renewable energy can be seen in table 4.1.

**Table 4.1**  
**Potential renewable Energy in Indonesia**

No	Renewable energy	Resource (R)	Installed Capacity (IC)	Ratio (%)	IC/R
1	Hydro	75.000 MW	8.111,00 MW	10,81 %	
2	Geothermal	29.475 MW	1.403,50 MW	4,8 %	
3	Biomass	32.000 MW	1.740,40 MW	5,4 %	

4	Photovoltaic	4,80 kWh/m <sup>2</sup> /day	71,02 MW	
5	Wind energy and Hybrid	3 – 6 m/s	3,07 MW	
6	Ocean	61 GW <sup>***)</sup>	0,01 MW <sup>****)</sup>	
7	Uranium	3.000 MW <sup>*)</sup>	30,00 MW <sup>**)</sup>	

\*) Potent only in WestKalimantan \*\*)as central research, non-energy

\*\*\*)Source:BadanLitbang ESDM, 2014\*\*\*\*) Prototype BPPT

Supply of electrical energy National in 2014 amounted to 53.352 MW comprising of energy Fossil amounted to 42 022 MW (79%) and renewable energy amounting to 11,330 MW (21%) and the desired target in 2019 amounted to 96 320 MW with an explanation of energy Fossil amounted to 79 366 MW (82%) and renewable energy amounting to 16 954 MW (18%), so that the energy shortage of 42 968 MW, based on these data, to reach the target until 2019 is not an easy job, whereas by 2025 the supply of electrical energy national target of 115 MW with a share of renewable energy by 23%.

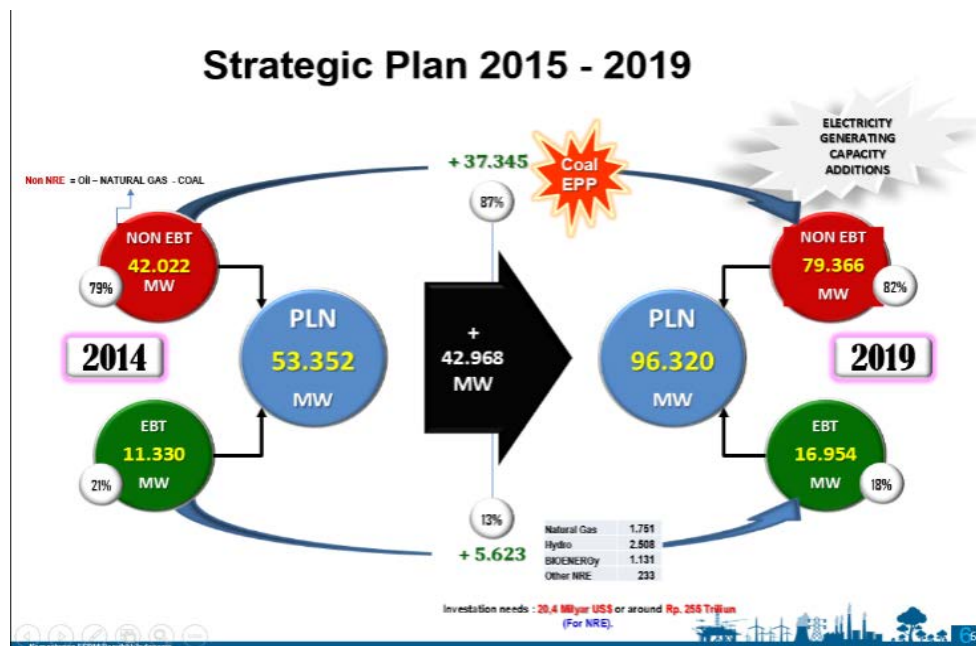

Source :ESDM

## STRATEGY DEVELOPMENT RENEWABLE ENERGY IN INDONESIA

Strategy of renewable energy development in Indonesia is strengthening the role of renewable energy in the energy mix:

1. Formulate the joint regulation of land use for power generation.
2. Accelerating the role of the private sector and the industry as a renewable energy-based electricity provider: Improvements in the licensing mechanism and optimization of synergies with PLN Establish industry-based electricity provider EBT recipients Investment Allowance.
3. Strengthening the role of renewable energy in the energy mix: (i) incentives and the right price to encourage investment; (ii) the use of various renewable energy and bio-energy for power generation, and (iii) the use of biofuels
4. Improving Accessibility: supplying electricity to islands and remote villages including the village of fishermen if possible with solar energy and other renewable energy.
5. Improving efficiency in energy use: (i) energy-saving campaign, (ii) developing incentives and funding mechanisms For financing of energy efficiency measures; (iii) increase the technical capabilities of managers and energy auditors; (iv) an increase in the role and capacity of energy services company (ESCO), (v) the development of the use of energy-efficient systems and technologies in the industry, (vi) the optimization of the energy conservation policy instrument (PP No. 70/2009 on Energy Conservation
6. Encouraging investment in PLT PLT Micro Hydro and Solar through Private and Other Business Entities in the Provision of Electricity from Renewable Energy, through the establishment of feed-in tariff (for System On-Grid) to PLT PLT Micro Hydro and Solar appropriate economic price;
7. Encourage enhanced the ability of domestic industries to produce components PLT PLT Micro Hydro and Solar;
8. Increasing national electricity supply through the development of geothermal and water power plants;
9. Increasing accessibility to electricity in remote, small islands and border areas using micro-hydro and solar energies;
10. Increasing electricity supply using agricultural waste and municipal solid waste based bioenergy;
11. Increasing utilization of biofuel (solid, liquid, and gas) for oil fuel substitution;
12. Development of new energy ( Technology Uranium and Thorium energy)

## REFERENCES

1. AusAID – ASEAN, AAECF Energy Policy and System Analysis Project, *Third National Policy Study for Indonesia, The Future Technologies for Power Plant in Indonesian Regions with Particular Reference to the Use of Renewable Energy and Small Scale Coal Steam Power Plant*, 2004
2. BPPT, *Energy Demand Forecast for the Period 2002 up to 2025 Using MAEDModel*. Jakarta
3. ChayunBudyono (2003) *Tantangan dan Peluang Usaha Pengembangan Sistem Energi Terbarukan di Indonesia*. Konvensi Kelistrikan Indonesia 2003.
4. Departemen ESDM, *Pedoman dan Pola Tetap Pengembangan Industri Ketenagalistrikan Nasional 2003 -2020*

5. DJLPE, Kepmen Rencana Umum Ketenagalistrikan Nasional (RUKN) 2005-2025
6. Didik Notosudjono, Presentasi pada Institute for Science and Technology Studies Representation of Europe mit dem Thema "Renewable Energy Potential and its Possibility as Electric Energy Alternative in Villages in Indonesia", Paderborn, 4. – 5. September 1998
7. Didik Notosudjono, Presentasi Windpower 1993, mit dem Thema „Hybrid system (Small Wind Energy and DC – Diesel Generator sets) for Electricity in the Village Ciparanti in Western Java, Indonesia", San Francisco, 12. bis 16. Juli 1993.
8. Didik Notosudjono, Seminar "Perspective Angepaßten Photovoltaic und Industrie für Energie System in Dorfern, Das Amt Bewertung und Anwendung Technologie (BPP. Teknologi) zusammenarbeit mit BMFT, Republik Federal Deutschland, 16. November. 1993, Zertifikat
9. Didik Notosudjono, Pembicara "Pengembangan system Hybrid PLTD-PLT Bayu untuk mendukung Grid Kepulauan di Nusa Tenggara Timur, Seminar Nasional , Soebardjo Brotohardjono III, Jurusan Teknik Kimia, UPN Veteran Surabaya, Jawa Timur, 10-11 Agustus 2006
10. Didik Notosudjono, *Keynote Speaker “ Biomass Power Plant from waste energy in Palm Oil” Seminar Nasional, Departemen Pendidikan Nasional Republik Indonesia Kantor koordinasi Perguruan Tinggi Swasta Wilayah IV, Bandung Jawa Barat, 18 Juli 2006*
11. Dr.rer.Pol. Ir. Didik Notosudjono Msc. International Seminar, Strategy, market and development photovoltaic in indonesia, Pakuan University and Agency for Assessment and Application Technology, Spanyol, 6DV.4.17 Visual Poster Presentation Acceptance 23rd EUPVSEC, [www.photovoltaic-conference.com](http://www.photovoltaic-conference.com), September 2008
12. Prof. DR. Ir.H. Didik Notosudjono, Msc Internasional Seminar, Challenge to implementation: waste energy from palm oil in Indonesia grid,., Pakuan University, Hanoi Vietnam , October 2009
13. Prof. Dr-Ing Ir. H. Didik Notosudjono and Dimas Bangun Fiddiansyah. ST Msc, Internasional, Seminar, The Future of PV Development in Indonesia,., Lampung, 16 April 2009

# The key to regional energy planning towards a 100% renewable electricity system for ASEAN

Pitoon Junthip

Dipl.-Ing. Wulf Boie, Prof. Dr. August Schläpfer,  
Department of Energy and Environmental management, University of Flensburg  
pitoon\_jun@yahoo.com

## Keywords

a 100% renewable electricity, Large-scale energy storage

## I. BACKGROUND

A Large-scale energy storage plays an important role in promoting a 100% renewable electricity system for regional energy planning, its purpose is to store the excess electricity when there is a low demand of electricity and recharging the stored electricity back to the system when there is a high demand of electricity. Practically, there are three technologies (pumped storage, compressed air energy storage and gas storage), which can deal with storage capacities from GWh to TWh and the installed capacities from 100 MW to larger GW scale [1]. According to a scenario of promoting a 100% renewable electricity of Germany by German Advisory Council on the Environment, the Norwegian pumped storage was used as a regional battery, its capacity of storage potential will up to 84 TWh, to store the excess-renewable electricity from Germany and EU countries via high voltage transmission lines from Germany, crossing Denmark, to many reservoirs in Norway [2].

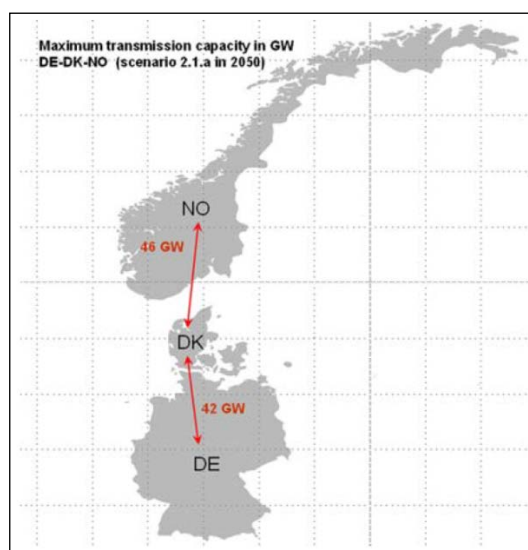

**Figure 1:** Maximum transmission line capacity for the German-Danish-Norwegian inter-regional network by 2050

## II. OBJECTIVES

There are two main purposes of this research which are: to propose a scenario of promoting a 100 % renewable electricity system of Thailand by 2050, and to introduce a potential of large-scale energy storage of Thailand using as a battery of ASEAN.

## III. METHODOLOGY AND FINDINGS

### 1. Projection of electricity demand and renewable electricity potential for Thailand and ASEAN-5

By 2050, the final electricity demand of Thailand will be up to approximately 466 TWh based on an adoption of 20% of energy efficiency potential [3,4]. This will require an amount of 523 TWh of the total electricity generation in order to cover the transmission losses and electricity consumption of power plants. However, the renewable electricity in Thailand will amount to 296 TWh, which will come from bio-energy, including biomass, biogas and waste (25%); solar PV (24%); onshore wind (23%); offshore wind (18%); hydroelectricity (10%); and the rest, including solar CSP, geothermal and wave and tidal (0.26%) [5]. Thus, it is a fact that this potential will not satisfy the required electricity generation by 2050, when it would be necessary to import the renewable electricity from neighbouring countries. There is great potential for renewable electricity of ASEAN-5<sup>1</sup> countries, which will amount to 1,722 TWh by 2050, whereas the electricity demand will require only 1,080 TWh; the surplus renewable electricity will be 642 TWh [4]. From this, Thailand will need to import the surplus renewable electricity accounting for 35% (227 TWh) of the surplus generation from ASEAN-5, as shown in Figure 2.

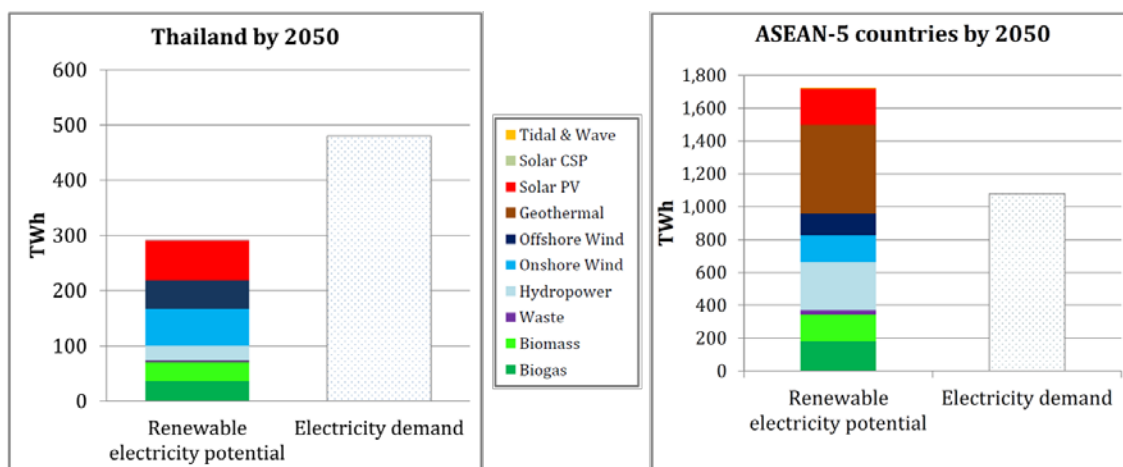

Figure 2: Electricity demand versus renewable electricity potential of Thailand and ASEAN-5

<sup>1</sup> ASEAN-5 countries are Indonesia, Malaysia, the Philippines, Singapore and Vietnam.

## 2. Exploring the large-scale energy storage potential in Thailand

### 2.1 Salt cavern potential of Thailand.

From geological information, there are two basins of rock salt in northeastern Thailand, which are the Khorat basin and Sakon Nakhon basin (the second basin) as shown in Figure 3. The total area of the two rock salt basins is approximately three times larger than the whole area of Schleswig-Holstein. Regarding the estimated quantity of salt rock, Suwanich has estimated that the geologic reserve of the three salt layers for both basins amounts to 18 trillion tons [6]. For the lower salt rock layer, which is perfectly suitable for making a salt cavern, Vattanasak also estimated that the inferred reserve in the Khorat basin amounts to 20 billion tons excluding residential and national forest areas [7]. There was a study by Fuenkajorn about the potential of salt caverns in Thailand for compressed air energy storage (CAES), the study designed and determined an appropriate rock salt layer, the dimensions of the caverns (including size, volume, shape and depth) and the possible locations of salt caverns in these areas [8]. Figure 3 shows the result of the study. It proves that the designed salt caverns will remain mechanically stable for at least the next 50 years and could be appropriately used as CAES.

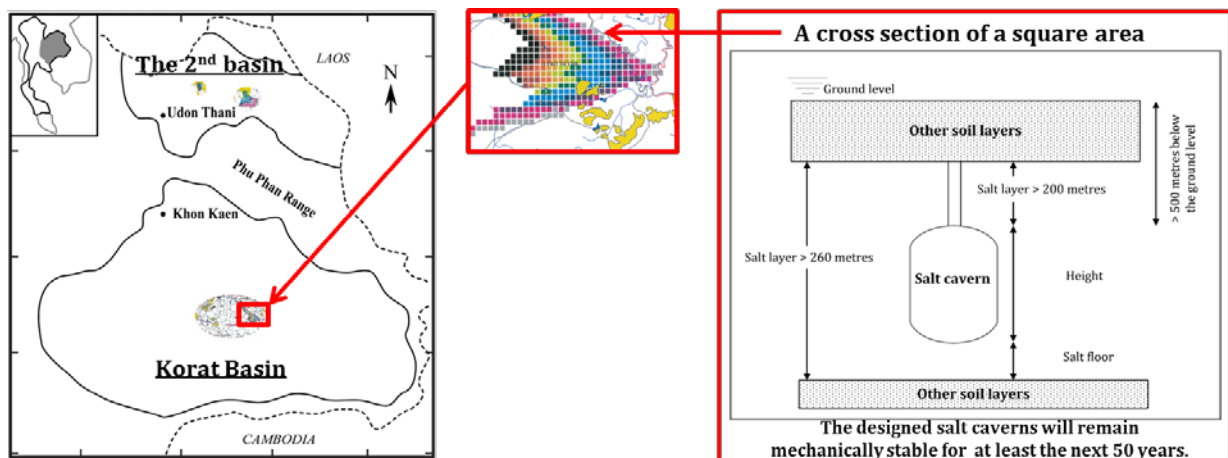

**Figure 3:** The brief result of salt cavern potential in Thailand, modified from Fuenkajorn [8]

### 2.2 Energy storage potential for AA-CAES<sup>2</sup>.

According to the salt cavern potential of Thailand, the author has estimated that the potential of AA-CAES, by adopting the volumetric energy storage density of AA-CAES, is 2.9 kWh per cubic metre of gas volume based on the different pressure of the salt cavern is 2 MPa [1]. However, the designed salt cavern of Fuenkajorn could be pressurised up to 5.9 MPa. Thus, the volumetric energy storage density would amount to approximately 8.56 kWh per cubic metre of gas volume. As a result, the potential of AA-CAES will be up to 59 TWh for a single salt cavern, or for a double salt cavern, it will up to 119 TWh (based on one cycle of storing and withdrawing energy from a salt cavern), as shown in Table 1. This potential could be

AA-CAES<sup>2</sup>: advanced adiabatic-compressed air energy storage

used as a giant battery for Southeast Asia, which is similar to using the potential of pumped storage in Norway as energy storage for North Africa and all of Europe, according to the SRU's scenario [2].

**Table 1:** The summary data of AA-CAES potential in salt caverns of Thailand

The summary data of AA-CAES (unit)	Type of salt caverns	
	A single cavern	A double cavern
Number of salt caverns (caverns)	958	1,916
Total volume of salt caverns (million cu.m.)	350	700
Energy storage potential (TWh)	59	118

### 3. Pathway toward a 100% renewable electricity by 2050

There are four steps for developing this pathway,: 1) phasing out conventional power plants; this means there will be no more conventional power plants after 2022, including the imported electricity generated from fossil fuel (e.g. coal and fuel oil); 2) eliminating the new nuclear power plants, which are in the current energy plan; 3) filling the gap between the required electricity generation and the electricity generation from remaining conventional power plants by adding up new renewable electricity from the domestic potential; 4) importing the surplus renewable electricity from ASEAN-5 countries; an incentive for those countries to export their renewable electricity is that Thailand has a huge potential of large scale energy storage (i.e. AA-CAES) that can be used to store the surplus electricity. The result is shown in Figure 4.



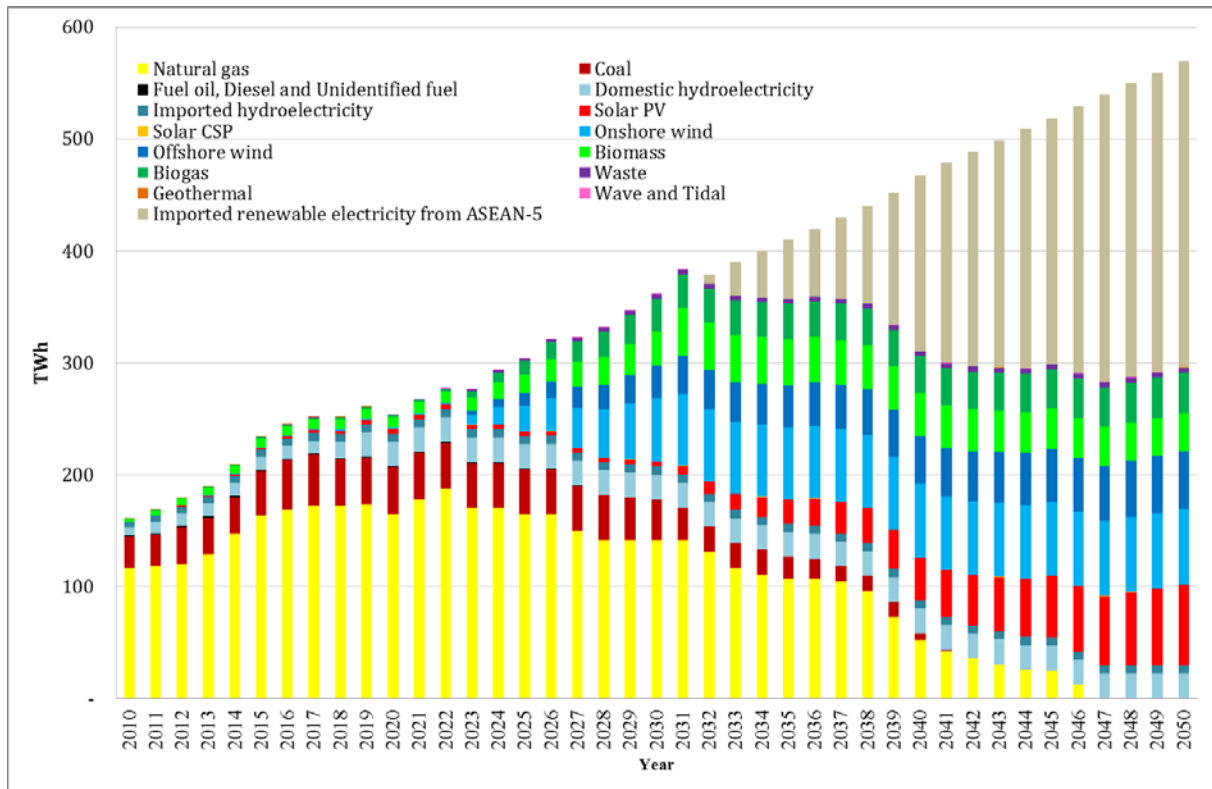

**Figure 4:** The pathway towards a 100% renewable electricity system by 2050 [9]

#### 4. Load profile and balance of load profile by 2050

##### 4.1 Load profile by 2050

It is necessary to develop the load profile which is helpful to observe the behaviour of load demand and electricity generated from renewables in a single hour by 2050. The author has developed the projection of load demand by applying the required electricity generation by 2050 based on the pattern of electricity generation from the national grid in 2010. Note that, the pattern of electricity generation in the load profile correlates well with the pattern of peak demand. For the behaviour of electricity generated from renewables, the author has developed by applying the availabilities of renewable energy resources, which can be generated from renewables to electricity in every hour in 2010. As a result, the load profile by 2050 is shown in Figure 5, which shows that there will be a large amount of the excess electricity coming from solar PV, onshore wind and offshore wind [9].

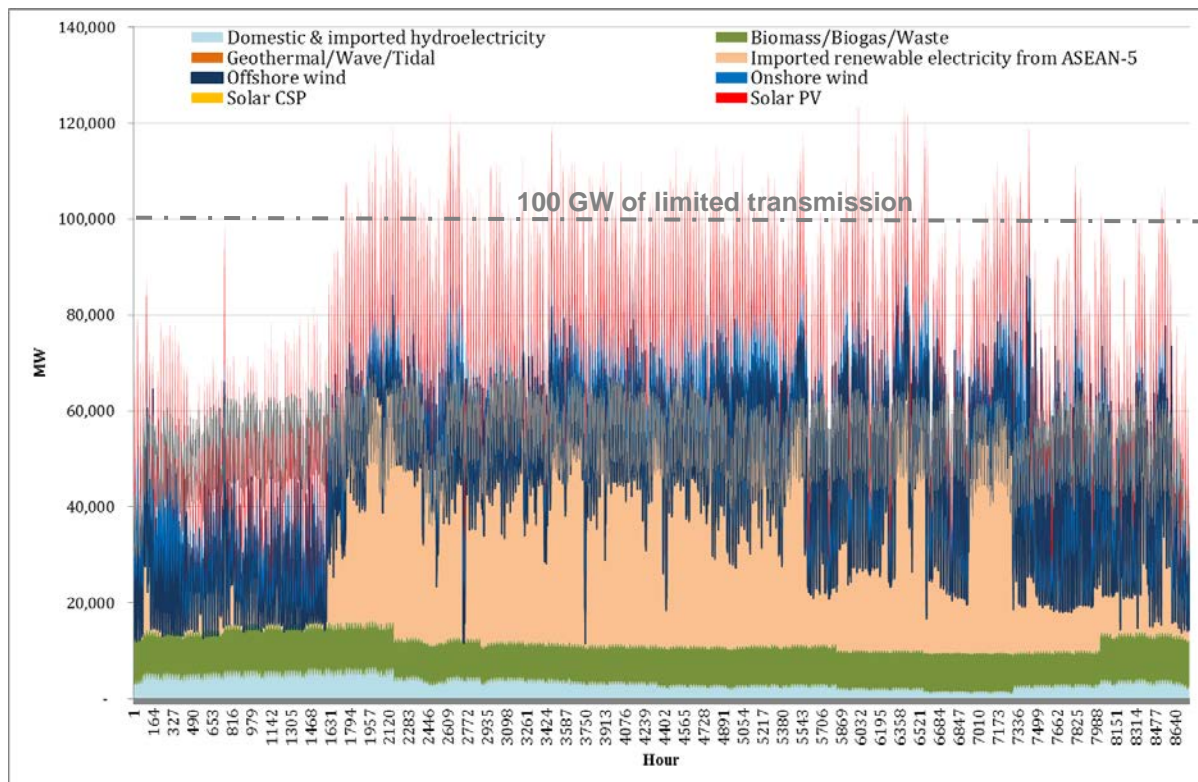

Figure 5: Load profile by 2050 for a 100% renewable electricity system in Thailand [9]

#### 4.2 Determining the limit of transmission capacity

It is important to consider to limits the transmission capacity by 2050 in order to determine the actual electricity which can be transmitted to energy storage or consumers by transmission system. Thus, the cost-effectiveness of determining the transmission capacity must be taken into account. For example, from Figure 5, if the transmission capacity is determined to equal the maximum power output (approximately 120 GW) which is rarely generated by solar and wind energy. This will be not economically for the transmission lines because there will be a few hours for transmitting the electricity to energy storage or consumers. On the other hand, if the transmission capacity is determined to equal 80 GW, there will be a smaller amount of electricity which is transmitted to energy storage or consumers compared to the amount of 120 GW of transmission capacity, even though there will be much opportunity for electricity transmitting. The author used the trial and error method to ensure that there will be the sufficient electricity to serve the electricity demand because there will be some energy losses during the process of storing and withdrawing energy. As a result, the appropriate transmission capacity is 100 GW which can lead to also limit the amount of the total electricity generation in the load profile for 2050 [22].

### 4.3 Balance of Load profile by 2050

The balance of load profile<sup>3</sup> is significantly helpful when determining the magnitude of surplus electricity and inadequate electricity which occur in different time of the year. From Figure 6, it shows that the electricity supply system requires the charging power from energy storage approximately at least an amount of 55,000 MW in order to store the excess electricity, whereas an electricity demand system requires approximately at least an amount of 35,000 MW from energy storage [9].

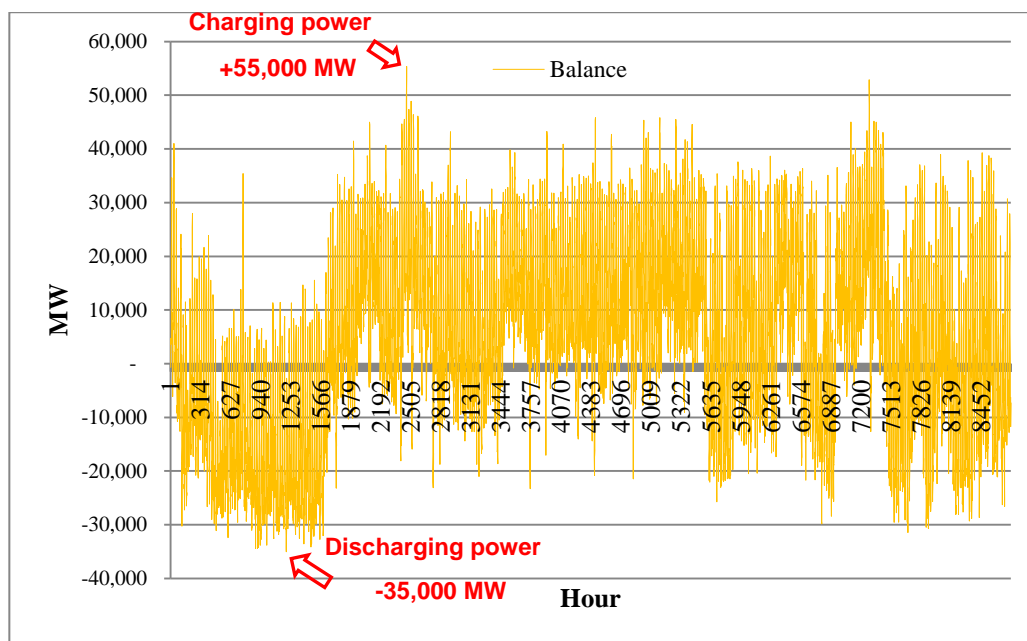

**Figure 6:** The balance of load profile by 2050 [9]

### 5. The mean generating cost for the whole electricity supply

Basically, the mean generating cost for the whole electricity supply is the ratio of the total cost (fixed and variable cost) of the whole electricity supply to the amount of the electricity generated from the whole electricity supply in a year; this is given in units of Eurocent per kWh. Note that the unit of the cost is expressed as constant price in 2009 ( $C_{t_{2009}}$ ) based on the average inflation rate from 2000 to 2012 which is approximately 2.65% [10]. For the projection of fuel cost in Thailand, the author has made a projection of the price of fossil fuel from 2011 to 2050 by using the fuel price of Thailand [11] as the starting point, and applying the growth rate of the fuel price from the projection of DLR (German Aerospace Centre) to this point until 2050 [2]. The result is shown in Figure 7.

For the cost of conventional power plants, renewable technologies and energy storage, the author has made an estimation based on a study of DLR [12]. As a result, Figure 8 shows that there are three lines of the mean generating cost for the whole electricity supply. In the

<sup>3</sup> The balance of load profile (known as the residual load) is the difference between total electricity generation and required electricity generation.

long-term, the generating cost for the whole electricity supply in this scenario (the blue line), generated from fossil fuel and renewable energy, will range between 4.7 and 7.6 Ct<sub>2009</sub> per kWh. At the end of 2050, the generating cost will fall to 6.0 Ct<sub>2009</sub> per kWh, which is 28% higher than the generating cost in 2010 [9]. However, the author made a comparison between the generating costs for the whole electricity supply, which is generated from only fossil fuel (see the brown line in Figure 8) in order to satisfy the electricity demand by 2050, and the generating cost of this scenario (see the blue line in Figure 8). From this, it can be found that after 2040, the generating cost from this scenario will be cheaper than the generating cost from only fossil fuel.

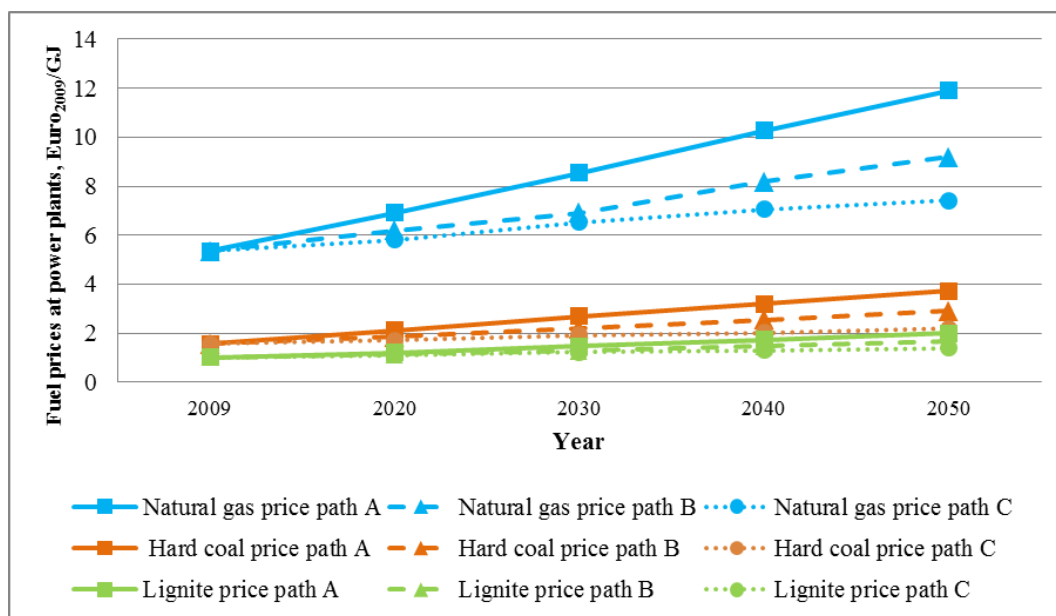

**Figure 7:** Projection of conventional fuel prices at power plants until 2050 for Thailand [9]  
(Fuel price path expression: A = a substantial increase, B = a moderate increase, and C = a low increase)

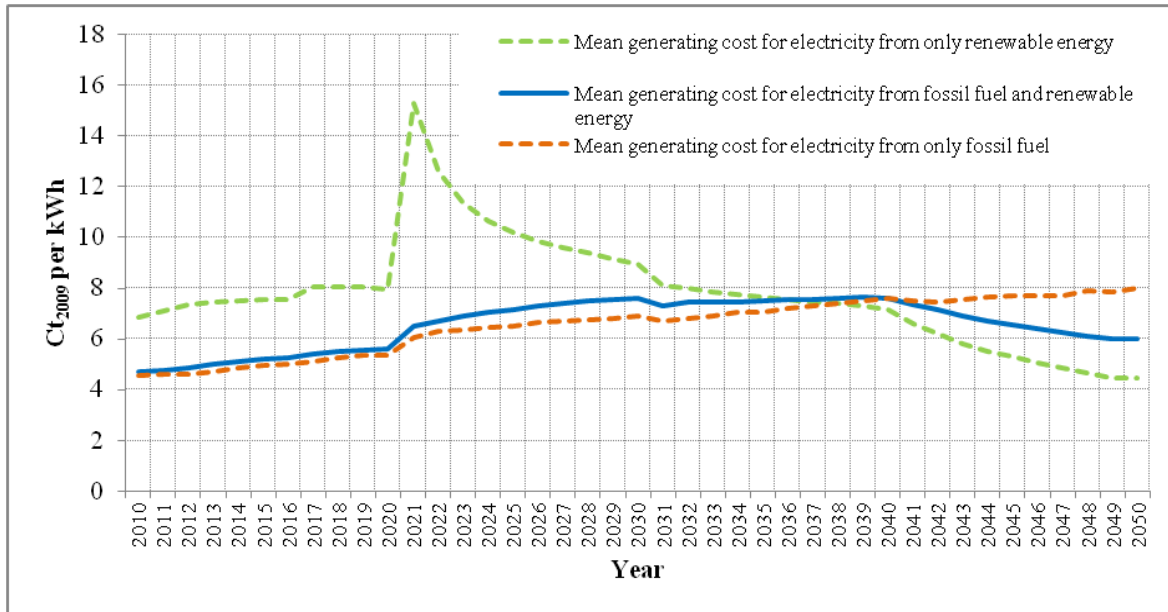

Figure 8: The mean generating cost for the whole electricity supply [9]

#### IV. CONCLUSION

In conclusion, it is evident that there is a high possibility (in terms of technical and economical feasibility) of promoting a 100% renewable electricity system for Thailand by 2050, which results in the elimination of new nuclear power plants suggested in the energy plan. Furthermore, Thailand has a huge potential of large-scale energy storage or AA-CASE that could be used as a battery of Southeast Asia. This would be the key of success for promoting a 100% renewable electricity system for this region.

#### V. REFERENCES

1. Kepplinger et al., Present Trends in Compressed Air Energy, SMRI Fall 2011 Technical Conference, p. 7, York, KU: Solution Mining Research Institute, 2011.
2. SRU, Pathways towards a 100% renewable electricity system, The German Advisory Council on the Environment (Sachverständigenrat für Umweltfragen, SRU), 2011.
3. Energy Policy and Planning Office (EPPO) database, Ministry of Energy of Thailand, [http://www.eppo.go.th/info/7economic\\_stat.htm](http://www.eppo.go.th/info/7economic_stat.htm). Retrieved on 5 February 2012.
4. The author based on the following sources: 1) Global Biomass Potential: Investigation and assessment of data Remote sensing in biomass potential research Country-specific energy crop potential, German Biomass Research Centre, 2008; 2) Role and Potential of Renewable Energy and Energy Efficiency for Global Energy Supply, German Federal Environment Agency, 2009; 3) Deploying Renewables in Southeast Asia: Trends and

- Potentials, IEA, 2010; 4) Renewable Energy: Markets and prospects by Region, Information paper, IEA, 2011; and 5) Energy [r]evolution 2010: A sustainable world energy outlook, EREC & Greenpeace, 2010.
5. The author collected data from EGAT, Statistical Report Year 2010, Annual report, Power Forecast and Statistics Analysis Department, System Control and Operation division p. 40, 2010.
  6. Suwanich, P., Potash in northeaster Thailand, Economic Geology Document No. 22, Department of Mineral Resources, 1978.
  7. Vattanasak, H., Salt reserve estimation for solution mining in the Khorat basin, *M.Sc. thesis*, Institute of Engineering, Suranaree University of Technology, School of Geotechnology, 2006.
  8. Fuenkajorn, K. Assessment of mechanical potentials of rock salt for compressed air energy storage in northeastern Thailand, Department of Alternative Energy Development and Efficiency, Ministry of Energy, 2010.
  9. Junthip, P., Shaping the electricity system of Thailand towards sustainability, *M.Eng. thesis*, Energy and Environmental Management, International Institute of Management, University of Flensburg, 2012.
  10. Trading economics, [www.tradingeconomics.com/thailand/inflation-cpi](http://www.tradingeconomics.com/thailand/inflation-cpi), Retrieved on 21 July 2012.
  11. Nakawiro et al., Expanding electricity capacity in Thailand to meet the twin challenges of supply security and environmental protection, *Energy policy*, pp. 2265–2278, 2008.
  12. DLR, Langfristszenarien und Strategien für den Ausbau der erneuerbaren Energien in Deutschland bei Berücksichtigung der Entwicklung in Europa und global (Leitstudie 2010), 2010.

# Energy Development in Supporting Sustainable Development in Indonesia

Ira Fitriana

Center for Technology of Energy Resource and Chemical Industry  
Agency for The Assessment and Application of Technology (BPPT)  
fitriana.ira@gmail.com

## **Abstract**

Currently the use of energy in Indonesia is still highly dependent on fossil fuels, especially oil, whereas coal and natural gas potential is greater. In addition, Indonesia also has abundant resource of new and renewable energy. To support sustainable development in both economic and social aspects that are environmental friendly, energy development strategies are needed. The government has set the regulation 61/2011 on RAN-GRK to reduce greenhouse gas (GHG) emissions by 26% at their own expense and reaches 41% with international assistance in 2020 from the business as usual (BAU) condition. National Energy Policy in PP 79/2014 also encourages the use of EBT of at least 23% by 2025. Targets for GHG mitigation would be extended until 2030, as the Government's commitment in the COP21 which stated GHG mitigation targets of 29% at their own expense or 41% with international assistance as outlined in documents Intended Nationally Determined Contributions (INDCs) Indonesia. Efforts to meet the energy sector GHG mitigation is performed by the utilization of renewable energy (solar, micro-hydro, geothermal, landfill, wind, biodiesel, and biomass), efficient use of technology, and substitution of fossil fuels fuel / coal into gas. The implementation of all various mitigation efforts will take into account the economics

KEYWORDS: sustainable development, new and renewable energy, GHG mitigation

## **I. BACKGROUND**

Currently the population in Indonesia has reached about 252 million, but the final energy consumption per capita is still quite low at 4.63 BOE / capita (0.64 TOE/capita) with the electricity consumption is only 764 kWh / capita. As a comparison, Malaysia and Singapore have already reached about 2,674 kWh / capita and 7.403 kWh / capita in 2011<sup>(8)</sup> respectively. This gives an opportunity for Indonesia to increase the level of energy consumption but with attention to the preservation of the environment's elements. Increased energy consumption for a large population of Indonesia requires substantial energy supply. Currently the development of the world economy is quite low which affects the GDP growth in Indonesia. In 2014, Indonesia's economic growth rate of only 5.02%. It is expected that

Indonesia economy can be increased in order to encourage its growing energy demand in the future.

Energy consumption in Indonesia is still dominated by fossil fuels, such as petroleum, coal and natural gas. Meanwhile new and renewable energy (NRE) resources such as geothermal, solar, wind, biomass and biofuels are quite large, which can be applied as fuel substitution. But the utilization of NRE is still very small at about 7.6% of the national energy supply. With the decreasing supply of fossil energy, Indonesia has to begin to consider the use of renewable energy to meet the growing energy demand.

According to the Regulation no. 32 In 2009, the development of Indonesia adheres to sustainable development that is a conscious and planned effort that combines aspects of environmental, social, and economic development strategies to ensure the needs of the environment and safety, capability, welfare, and quality of life of the present and future generations. Thus, the development should be done through a low-emission development strategies.

The increasing of energy consumption with the high use of fossil energy will encourage GHG emissions to grow significantly. Under Bali Agreement at The 13<sup>th</sup> Conferences of Parties (COP) of United Nations Frameworks Convention on Climate Change (UNFCCC) and the results of the COP-15 in Copenhagen and COP-16 in Cancun as well as the G-20 meeting in Pittsburg, the Government of Indonesia commits in lowering greenhouse gas emissions by 26% at their own expense and reach 41% with international assistance in 2020 from the BAU condition<sup>(2)</sup>. Then the government increased the targets by 29% at their own expense and by 41% with international assistance which is outlined in Intended Nationally Determined Contributions (INDCs) Indonesia in 2030. GHG emission reduction targets apply to all sectors of emitters which includes the energy sector, the sector Industrial Process and Product Use (IPPU), Sector Agriculture, Forestry and Land-Use Change (AFOLU), and Waste Sector. This study emphasizes the role of energy sector in reducing GHG emissions.

## **II. OBJECTIVES**

Evaluate the impact of utilization of sustainable energy in Indonesia in the form of NRE utilization and energy conservation to the reduction of GHG emissions in accomplishing the targets of 29% at the government own expense, or 41% with international assistance, as outlined in documents Intended Nationally Determined Contributions (INDCs) Indonesia.

## **III. METHOD**

Energy supply is forecasted using optimization method with energy demand projection as an input, which called 'demand driven'. Energy demand projection is calculated using BPPT Model for Energy Demand of Indonesia (BPPT-MEDI) developed in 2010 which is a development of MAED model that is adapted to Indonesia conditions. The input data that forms the basis of this model is population and the national economy data which then projected based on historical data as well as information related to demographic and economic developments nationally. This long-term energy demand is broken down into five sectors namely industrial, household, transportation, commercial and other sectors. The energy demand projection data is then used as input for MARKAL model in projecting the energy supply.



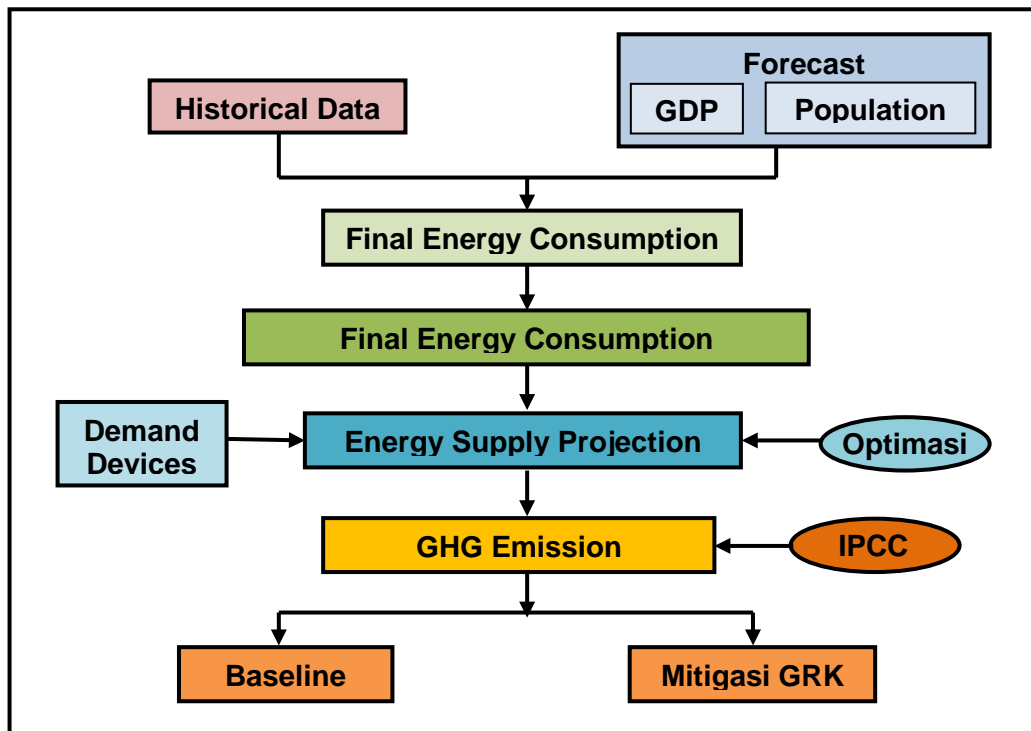

Picture 1. Scheme to analyse Green House Gas (GHG) from energy sector

Furthermore, the obtained long-term projections of energy supply per type of fuel and technology used in the process of energy is used to calculate GHG emission using the IPCC. Baseline scenario does not take into consideration all forms of mitigation in process technology, demand device technology and utilization of NRE; while mitigation scenario considers all aspects affecting the emission reduction.

Methodology used in calculating GHG emissions is the IPCC -2006. Emission factor (EF) used in GHG emissions calculation differentiated into three groups, namely:

- Tier-1 for the combustion of coal and natural gas, fugitive emissions, as well as CH<sub>4</sub> and N<sub>2</sub>O emissions for fuel combustion.
- Tier-2 for burning fuel, especially CO<sub>2</sub> emissions.
- Tier-3 for CO<sub>2</sub> emissions from the use of natural gas as feedstock for the fertilizer industry.

The equation used in the method of calculation of GHG emissions are<sup>(7)</sup> :

$$Emissions_{GHG, fuel} = Fuel\ Consumption_{fuel} \times Emission\ Factor_{GHG, fuel}$$

with :

Emissions<sub>GHG, fuel</sub> = emissions of a given GHG by type of fuel (kg GHG)  
 Fuel Consumption<sub>fuel</sub> = amount of fuel combusted (TJ)

Emission Factor<sub>GHG,fuel</sub> = default emission factor of a given GHG by type of fuel (kg gas/TJ). For CO<sub>2</sub>, it includes the carbon oxidation factor, assumed to be 1.

## IV. RESULTS

### The Forecast of GDP and Population

The development of national economy expressed in its Gross Domestic Product is strongly influenced by the level of world economy. In the base year 2013, Indonesia's economic growth rate reached 5.21%. But then in 2014, it experienced a slight decrease of 5.02% and is expected to still decreasing in 2015. Then in 2016, GDP growth rate is expected to increase and will continue to do so until 2030. Average growth rate assumption during the period 2013-2030 in this study is quite optimistic at 7.2%. This could boost Indonesia's economy so that it can pass through Middle Income Trap in 2025 and Indonesia could move into the developed world countries zone.

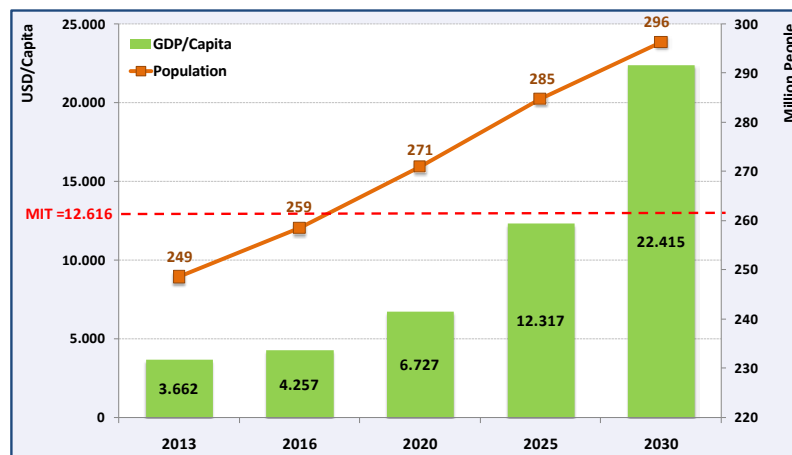

Picture 1. The forecast of GDP and population<sup>(3)</sup>

According to historical data, the growth rate average of Indonesia's population is about 1.4% and is expected to decline further down the line. Average growth rate of the population in the period 2013 - 2030 is at 1% and to become 296 million by the end of period. With a large population, it should be noted that Indonesia needs a large energy supply to meet its energy demand.

### Long-Term Energy Demand

Final energy demand consists of five sectors, namely industry, transport, households, commercial and others. Various types of petroleum fuel are predominantly use in the

transport sector and other sectors, coal and natural gas in the industrial sector, LPG in household and commercial, electricity in the industrial sector, household, and commercial. Biomass used in the household sector is firewood that is used as a cooking fuel, especially in rural areas. But the use of firewood for cooking will decrease given the increasingly diminishing resources and the inefficient technology, and get along with access to commercial energy (LPG) more widely and evenly.

Technology in the industrial sector, such as boilers, furnaces and motor drive will tend to use the efficient equipment in order to increase production and industrial competitiveness. While the transport sector as the supporting of industrial sectors and community activities will also grow along with the economy. Although some vehicles already utilizing efficient technology and mass number of vehicles continues to increase, but the pace of growth in the number of vehicles are not able to restrain the rate of fuel consumption. Electricity usage will also rise due to its economical and efficient value. Petroleum fuel will continue to increase at an average growth rate of 5.1%. Its share of total final energy requirement remained steady at 36%. Coal and natural gas is projected to increase quite rapidly at 6% per year.

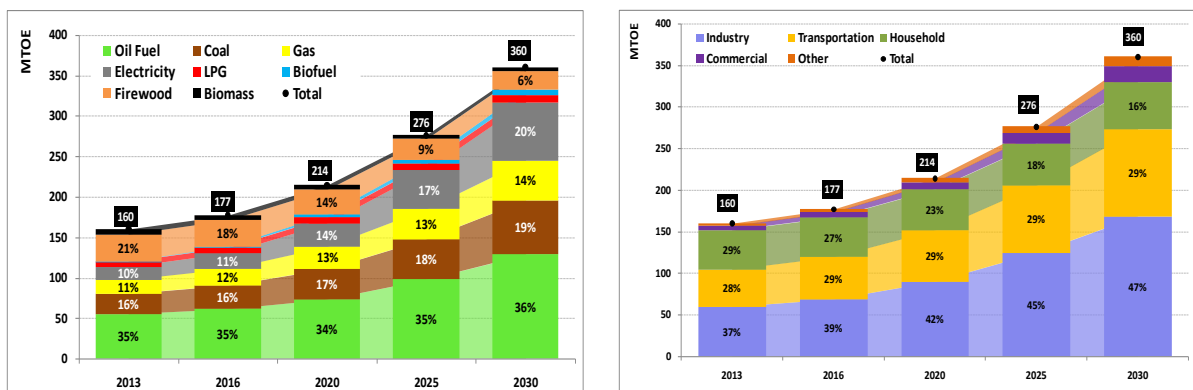

**Picture 2. The forecast of energy demand per type and per sector <sup>(3)</sup>**

Electricity demand will rise quite high, about 9.2% per year. The increase in LPG usage is accordance with the development of the household sector at 2% per year. While the use of biofuels during the period 2013 - 2030 increased sharply by 23.7% due to the biofuel mandatory.

As the backbone of national economy, the industrial sector is expected to continue to increase and dominate the final energy demand, followed by the transport sector as a supporting sector of economic activity. It is estimated that the industrial sector grows at an average of 6.3% per year. Followed by the transport sector with an average growth rate of 5.1%. The growth of final energy demand will drive the energy supply projection.

### Long-Term Energy Supply

Based on optimization for long-term energy demand, supply of primary energy for period 2013 - 2030 is calculated with an average growth rate of 6.1%, an increase of nearly 3-fold

from 197 MTOE to 539 MTOE. To meet the energy demand, energy supply is still dominated by fossil energy, especially coal as a power plant fuel. Likewise, the oil and gas, which increases by an average growth rate of 5.1% and 5.2% respectively. To meet the demand of petroleum, Indonesia has to import both crude as intake as well as the petroleum fuel it self.

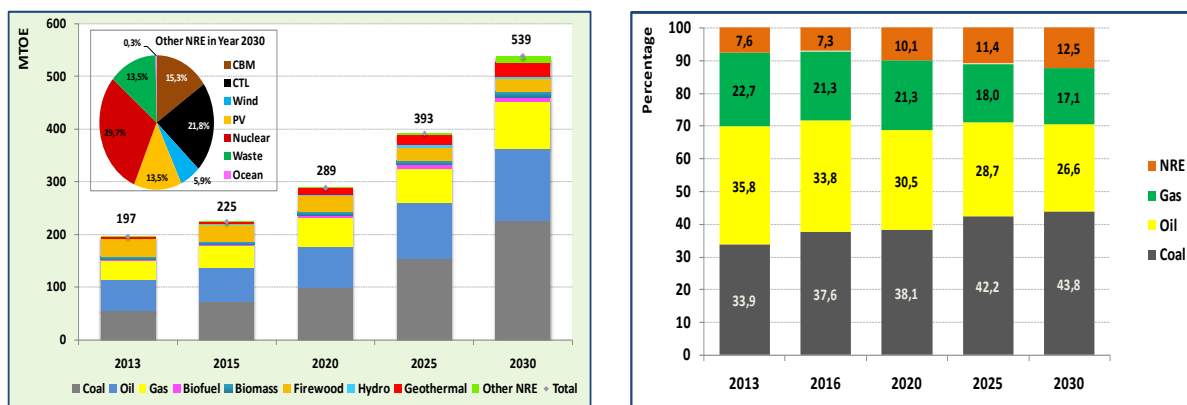

Picture 3. The forecast of energy supply <sup>(3)</sup>

In this study, the role of EBT considered in 2013 are largely met from biomass, followed respectively by geothermal, hydro or water power, biofuels, solar, and wind, with a total role of 7.6%. But then the composition in 2030 will change into geothermal, biomass, biofuel, hydro, nuclear, CTL, CBM, sun, wind and marine and its role is increase to approximately 12.5%.

The study results (11.4% in 2025) are lower when compared to Government Regulation No. 79/2014 regarding the National Energy Policy which states that in 2025 share of renewable energy is 23%. This is caused by the lack of investment in NRE technology development and applied energy price. In addition, the efficiency of utilization of renewable energy as a power plant still can not compete with fossil fuels. Although the feed-in-tariff for some types of renewable energy will be applied, it still can not attract foreign investors to open a renewable energy business opportunities in Indonesia. Moreover the global prices of fossil fuels continue to decline.

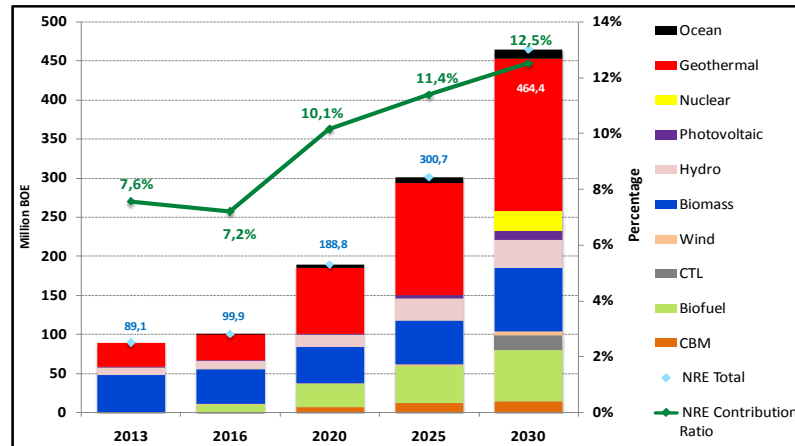

Picture 4. The forecast of New and Renewable Energy (NRE) and ratio of NRE role in Energy Supply <sup>(3)</sup>

NRE power generation that can be used to as a base load is only geothermal power plants. But this type of power plant is a local resource with the location of geothermal resources in Indonesia is limited and the variation of vapor that is quite diverse, so not all utilization of geothermal power plants will lower the cost of the power generation system. Therefore not all geothermal power plants can supply the base load electricity. The efficiency of solar and wind power are still very small when compared to coal-based power plants especially with continuity of power production is not assured. The role of biofuels is still often confronted with price gap between its price as an energy and as feedstock for food. On the other side, Coal Bed Methane (CBM), Coal to Liquid (CTL) and Marine energy are still under development and has not been produced commercially yet as it require high investment. Nuclear is still the last preferred type of NRE because of its high cost of investment. Nuclear power plant will only be competitive if the costs of externalities utilization of coal power, to reduce the risk of disease and environmental damage caused by air pollution, is considered in the investment costs<sup>(3)</sup>.

In addition to the role of new and renewable energy, improving energy efficiency and energy conservation are also applied in this study. Advance the use of more efficient technologies in each energy sector will be considered as energy efficiency improvements, while energy conservation opportunities in the sector of end-use demand is through various efforts including the energy management efforts.

Table 1. Efficiency and Energy Conservation in Energy Sector

Energy Sector	Efficiency (%) *	Conservation (%)**
ACM (Agriculture, Construction, Mining)	0	10
Commercial	6 - 10	15 - 25

Industry	6 - 10	15
Households	8 - 25	15 - 25
Transportation	10 - 32	15

Source : \* Climate Change 1995 - Impact, Adaptation and Mitigation of  
Climate Change : Scientific-Technical Analyses

\*\* RIKEN (Master Plan of the National Energy Policy =Rencana Induk  
Kebijakan Energi Nasional)

## GHG Mitigation

GHG is measured from the type of fuel and technology used in energy demand. GHG mitigation considered in this study is energy conservation, energy efficiency and renewable energy utilization. GHG emission type calculated in this study are CO<sub>2</sub> (energy and IPPU), CH<sub>4</sub> (energy), and N<sub>2</sub>O (energy). Global warming potential for CH<sub>4</sub> is 23 and for N<sub>2</sub>O is 296<sup>(1)</sup>. Definition of Baseline Scenario according to Minister of Environment Regulation No. 15 of 2013 on the Measurement, Reporting and Verification of Climate Change Mitigation Action is the amount of GHG emissions in the absence of climate change mitigation actions.

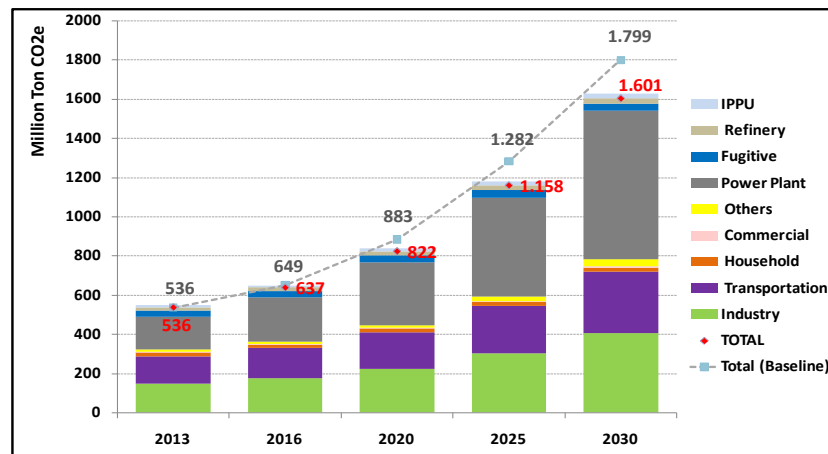

Picture 5. CO<sub>2</sub> Emission based on Energy Supply  
(Baseline and Mitigation Scenario)<sup>(3)</sup>

From the calculation, GHG emissions at base year 2013 in both baseline and mitigation scenario is 536 million tonnes of CO<sub>2</sub>e. In 2030, GHG emissions in baseline scenario is amounted to 1,799 million tonnes of CO<sub>2</sub>e, and in mitigation scenario is 1.601 million tonnes of CO<sub>2</sub>e or decreasing 11% against the baseline (198 million tonnes of CO<sub>2</sub>e difference). GHG emission reduction plan in 2030 listed in the regulation of GHG Emission Reduction

Plan 61/2011 and INDC is amounted to 222 million tonnes of CO<sub>2</sub>e<sup>(9)</sup>, then when the mitigation scenario is combined with other mitigation measures such as optimizing the use of renewable energy supported by the policies of the Government, the plan targets can be achieved.

## V. CONCLUSION

The level of energy consumption per capita in Indonesia is still low and still can be improved. To support the sustainable development, the government should not only be concerned on energy demand but also pay attention to integrate aspects of environmental, social, and economic to ensure the needs of safety, capability, welfare, and quality of life of the present and future generation. Therefore, a strategy to optimize the utilization of energy with efficient, environmentally friendly, and affordable technologies is crucial.

The utilization of sustainable energy with moderate assumption in the rate of economic and population growth will reduce GHG emissions by 0.197 million tonnes of CO<sub>2</sub>e, or 89% of the emission reduction targets in the energy sector which targeted **0.222** million tonnes of CO<sub>2</sub>e<sup>(9)</sup>. Although the share of EBT in 2025 with target at 23% could not be reached, however with the improving of technology efficiency and the energy conservation will reach 89% of GHG Emission Reduction Plan. If supported by other sectors such as the management of Land-Use, Land-Use Change, and Forestry and Waste, the 29% emission reduction target which was outlined in INDC of Indonesia at 0.849 million tonnes of CO<sub>2</sub>e in 2030 can be achieved and support the sustainable development in Indonesia.

## REFERENCES

1. Regulation no.32 In 2009 Protection and management of the environment (UU No.32 Tahun 2009 tentang Perlindungan dan Pengelolaan Lingkungan Hidup)
2. Presidential Regulation no.61 In 2011 : National Action Plan for Greenhouse Gas Emission Reduction (Perpres No.61 Tahun 2011 : Rencana Aksi Nasional Penurunan Emisi Gas Rumah Kaca)
3. BPPT, 2015. Indonesia Energy Outlook 2015 with theme Energy Development to Support Sustainability Development (Buku Outlook Energi Indonesia 2015, Pengembangan Energi dalam Mendukung Pembangunan Berkelanjutan), TIEM – BPPT
4. Intended Nationality Determined Contributions– Republic of Indonesia, 2015
5. CDIEMR (2011) *Handbook of Energy and Economic Statistics of Indonesia 2013*, Center for Data and Information on Energy and Mineral Resources, Ministry of Energy and Mineral Resources, Jakarta.
6. PLN (2014) *Rencana Usaha Penyediaan Tenaga Listrik PT PLN (Persero) 2015-2024*, PT PLN (Persero), Jakarta

7. 2006 IPCC Guidelines for National Greenhouse Gas Inventories
8. Elsevier, 2014, Vinod Mishra n, Russell Smyth; Convergence in energy consumption per capita among ASEAN countries
9. Bahan Rapat revisi lampiran perpres 61, Bandung, 15-16 Februari 2016
10. Bappenas, Perkembangan PEP RAN/RAD-GRK, Kaji Ulang RAN/RAD-GRK, Dan Penyusunan iNDC, Endah Murniningtyas, Deputi Sumber Daya Alam dan Lingkungan Hidup Kementerian PPN/Bappenas, 18 Mei 2015
11. Presentasi Alur Videografis Penyusunan Baseline Emisi Sektor Energi, Perpres 61/2011 Attachment, 2015



# **CHAPTER 2. ENERGY SYSTEM RESILIENCE TO ECONOMIC DYNAMICS AND CLIMATE CHANGE**

# Energy System Resilience to Economic Dynamic and Climate Change (Focusing on Local Adaption Plan for Action of Nepal)

Ranju Pandey

Nepal Electricity Authority

[ranjupandey@yahoo.com](mailto:ranjupandey@yahoo.com)

## Keywords

*Climate change, least-developed countries, National Adaption Programme of Action, low-carbon emission, socio-economic development, adaptation, Local Adaptation Plan of Actions, resilience, Alternative Energy, Improve cooking stoves, solar home system, micro hydropower plants, awareness, Improved water mills*

## BACKGROUND

Nepal contributes very low greenhouse gas emission, in contradictory; it is most vulnerable country to the climate change, like most of other least developed countries. According to the study, Nepal is ranked and listed fourth in global risk index of the most vulnerable countries due to Climate Change. Furthermore, 1.9 million Nepalese are highly vulnerable due to climate change. Nepal's remoteness, undulating terrain, fragile landforms, extremely diverse landscape, and evenly distributed resources and heavy dependency on natural resources has high impact of climate change. Hence, climate change has added additional challenge to the socio-economic development of the country. Therefore, to study and minimize the effect of Climate change like other least developed country, Nepal has prepared the National Adaption Programme of Action (NAPA) which was endorsed by the Government in September 2010 to support and help people to adapt to the adverse impact of climate change. Similarly, Government of Nepal has developed Climate Change Policy 2011, adopting a low-carbon emission socio-economic development path and supporting and collaborating the spirit of the country's commitments to national and international agreement related to climate change.

One of the emphases of this policy is implementation of community based adaptation plans as mentioned in the NAPA 2010. In this context, Nepal Climate Change Support Program (NCCSP) is commencing at the right time to assist the Government of Nepal (GON) in implementing the climate change policy (2011) and the NAPA; and to support other initiatives, including coordination mechanism as well as delivering climate adaptation results at the local level.

In line with the NAPA, the National Framework for Local Adaptation Plans for Action was developed to ensure that the poorest and most vulnerable communities in Nepal are able to adapt to the negative effects of climate change. This Local Adaptation Plans for Action has been identified as local adaptation actions with active people's participation to develop and implement adaptive action plans. This provides guiding principles for integrating climate change adaptation and resilience into local and national level planning in bottom-up,

inclusive, responsive and flexible manner. Hence, Local Adaptation Plan of Actions is the most urgent and immediate adaptation actions developed in order to increase the resilience of the climate vulnerable and poor people of Nepal. NCCSP has been designed in close collaboration with Government of Nepal, UNDPs and is in line with the National Adaptation Programme of Action (NAPA) to ensure that the poorest and most vulnerable communities in Nepal are able to adapt to the adverse impact of climate change.

## **OBJECTIVE**

The objective of the Programme is to ensure that the poorest and most vulnerable communities in Nepal are able to adapt to negative effects of climate change. Furthermore, the ultimate objective of the Programme is to enhance the institutional capacity via:

- i. Establishing and capacitating the institutional mechanisms at national and local level
- ii. Mainstreaming the climate change into Nepal's national development agenda and local planning process and
- iii. Collaborating with private sector in implementing Climate Change Actions including funding mechanisms.

## **APPROACH AND METHODOLOGY**

NCCSP has been implementing 100 Local Adaptation Plan for Actions (LAPAs) in 69 Village Development Committees (VDCs) and 1 municipality of 14 districts in the Mid and Far Western regions of Nepal for promoting community based adaptation through integrated management of agriculture, water, forest and biodiversity sectors. The thematic areas which is addressed in LAPAs for increasing adaptive capacity of vulnerable communities are Agriculture, Food Security, Livelihoods, Forest, Biodiversity, Water Resource, **Alternative Energy**, Infrastructure Development, Climate induced Hazards. Different activities are planned in these thematic areas and are conducted to improve the adaption capability of the vulnerable people in these communities.

The programme has twin track approach of linking bottom up (local) and top down (national) processes to create conducive environment for effective implementation of local level adaptation options. This approach will also ensure that climate adaptation is integrated into local development processes through local government, non-government organizations including private sector and community-based organizations.

Through NCCSP, LAPAs are being implemented in 14 districts. They are Achham, Bajura, Kailali in the Far Western region as shown in Figure 1 and similarly Bardiya, Dolpa, Humla, Jumla, Mugu, Dailekh, Jajarkot, Kalikot, Dang, Rolpa and Rukum in the Mid-western region. The areas covered have an approximate population of three million. The primary beneficiaries of the programme will be the poorest and most climate vulnerable people, particularly poor women and men from disadvantaged and marginalized groups. Other stakeholders include the district line agencies, community based organizations, non-government organizations, indigenous, groups, Ministry of Environment Science & Technology (MoSTE), the Climate Change Council, Ministry of Finance, Ministry of Federal Affairs and Local Development (MoFALD).



**Implementing Agencies**

The MoSTE has been leading the programme implementation in coordination with the MoFALD and Nepal DDCs/District Energy, Environment and Climate Change Sections (DEECCS). At the district level, DDC has been acting as the focal agency for implementation of the Programme through the DEES/DEEU or DEECC Sections.

Figure SEQ Figure \\* ARABIC 1. LAPAs

NGOs, CBOs and Private Sector are supporting support local level implementation by providing technical support, which is being facilitated by DEECCS. Likewise, UNDP is providing technical assistance to the programme. Implementation Modality of the programme is as shown in the Figure 2.

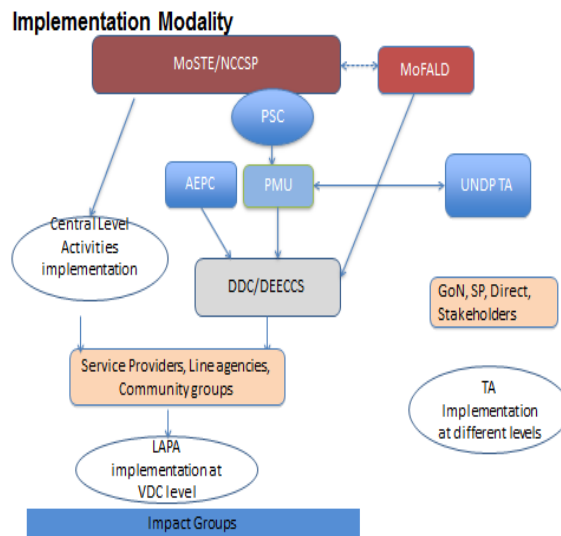

Figure SEQ Figure \\* ARABIC 2. Implementation Modality

## RESULT

### Renewables Energy for Resilience

As mentioned above, Alternative Energy is one of the major thematic areas that is addressed in LAPAs particularly to be economically sound and sustainable to cope with the calamities caused by climate change, that is mainly with the use of clean energy and promoting electricity related business mostly for the poor people. Construction of Improve cooking stoves, installation of the solar home system, construction of micro hydropower plants in suitable localities, construction of the decentralized power plants, increasing the awareness of using clean energies and improving the livelihood of the rural and vulnerable communities through the promotion of the clean energy and raising the employment opportunities with the increase in the manpower by giving training for installation of PV plants, building improve cooking stoves and house wiring trainings are the major LAPAs activities done in the communities and were successful too. Introduction of clean energy and developing various infrastructures like electrical mill in the vulnerable communities have increased the use of clean energy and reduced the use of fossil fuel like kerosene and traditional firewood. Additionally, capacity building in this field has increased income generating activities which has made the vulnerable people self-sustainable and their living standard has sufficiently improved. These are the major activities done to the community via LAPAs. Some of the best renewable projects implemented under LAPA activities are:

#### **i. Use of Improve Cooking Stoves**

In the remote Duli VDC of Rukum District, NCSSP has provided training for local women on how to change their kitchen environment by building improved cooking stoves as shown in Figure 3. This simple but effective technology can be made in homes at low cost with locally available resources and tools has changed life of the VDC people like Mina Gharti, she mother of six, was one of the first to pioneer the new cooking stove explains how the local villagers are enjoying a lot of benefits.

First of all, there is much less smoke and Mina and her children no longer feel suffocated when they cook. The stoves are also more efficient and use less fuel wood.

Using these stoves the people of her community are protecting their forest, and also themselves from future natural disasters. This ICS has save the time of the women as they spend less time for collecting fuel wood and cleaning utensils are much quicker. Improve cooking stoves has given healthier life for women.

Similarly, Harkamaya Pun of Rolpa district, after taking the Improve cooking stoves making training has started to construct the Improve Cooking Stoves in her own community. She has begun to contribute in generating income in her family. Figure 4 shows Harkamaya Pun constructing the Improve cooking stoves from the locally available materials.



Figure SEQ Figure \\* ARABIC 3.



### ii. Installment of Solar Home System

Installment of the solar PV has helped the poorest people in the village by providing lights to their houses as shown in Figure 5. Further children have been benefited for getting to study for longer period of time and women are getting longer time for their work.

### iii. Improved Water mill

Replacement of traditional water mill has been done through the installation of improved water mill. This has made life of villager, mostly women, much easier.

Figure SEQ Figure \\* ARABIC 4. Making

A part from installation of the clean energy (like micro hydro, Solar home system, Improve Cooking Stoves, Improved water mills), various capacity building trainings like ICS construction trainings, house wiring training, operation and maintenance of these renewable energy sources to the locals who are vulnerable to the climate changes has improve the income generating activities with subsequent improvement in their living standard.



Figure SEQ Figure \\* ARABIC 5. Installment of

Hence, rural people vulnerable to the climate change are using renewable energies system. This has helped to increase their adaption capability as they were aware of the calamities and are trying to cope with this with the use of clean energy.

# Towards a Framework for Resilient Monitoring & Control Systems Design: An Application in Network of Power Systems

Yul Yunazwin Nazaruddin and Tua Agustinus Tamba

Instrumentation and Control Research Group, Faculty of Industrial Technology

Institut Teknologi Bandung. Jalan Ganesha 10, Bandung 40132, West Java, Indonesia

E-mails: (yul,tamba)@tf.itb.ac.id

## *Abstract*

This paper presents our preliminary works on developing resilient monitoring and control framework to (i) forecast impending regime shifts and (ii) mitigate the onset of regime shifts. We show that the forecast can be formulated as a minimum-distance-to-bifurcation problem whose solution can also be obtained using an efficient convex optimization relaxation method. The proposed framework is illustrated through the study and evaluation of voltage collapse phenomenon in a model of single machine, infinite bus power system.

***Index Terms***—Resilience, regime shifts, bifurcation, distance to instability, convex optimization.

## I. BACKGROUND

A resilient system is one that maintains an active awareness of impending regime shifts from a normal operating regime to alternative faulty operating regimes and reacts to them in a manner that returns the system back to normalcy in a finite time interval. Such a regime shift is often observed as sudden changes in the structure or function of a system that arise due to the forces from external disturbances. In general, there are two scenarios in which regime shifts may occur. First, it may arise because the system has multiple equilibria and external stochastic disturbances drive the system's state between competing equilibria's regions of attractions (ROAs). This scenario will be referred to as noise-induced regime shifts. In the second scenario, regime shifts may occur when external disturbances cause variation in system parameter which eventually forces the system's equilibrium undergoes a bifurcation. This scenario will be referred to as bifurcation-induced regime shifts. In either scenario, regime-shifts can be catastrophic for users who have grown accustomed to the quality of services provided by the system prior to the shift. A better understanding of mechanisms leading to regime shifts and the impacts it has on a system's resilience is therefore important to help find urgent management actions that can be taken to avoid the undesired consequences that the shifts may cause.

An important framework that has been adopted in various studies of regime shifts is the concept of multi-stability or alternative stable states from dynamical systems theory [1-4]. Within these concepts, a regime shift has been viewed as a nonlinear dynamical behavior in which a system undergoes switches/jumps between alternative stable states after a

sufficiently large external disturbance pushes the system state off of its current or nominal stable regime. The underlying mechanisms or drivers governing such switches are often unknown for certain [1-4]. Nevertheless, the majority of works that have studied regime shifts usually assumed that the mechanism by which a shift occurred follows one of the following two general mechanisms:

- First, regime shifts occur through a bifurcation of the system's equilibria as external perturbations cause variation in system's parameters that exceeds some critical threshold. In this case, the regime shift is characterized by changes in the number (single or multiple) and types (stable or unstable) of system equilibria. Such mechanisms will be referred to as bifurcation-induced regime shifts.
- Second, regime shifts occur because the system's nominal regime (or operating point) has multiple equilibria and external stochastic disturbances drive the system's state to shift/jump between the ROAs of the competing stable equilibria. We will call this mechanism a noise-induced regime shift.

Below, we argue that the differences between these two mechanisms are in terms of how the perturbations affect the nominal system and what impact do they cause to the nominal system.

- In bifurcation-induced regime shifts, perturbations that cause the shifts are viewed as the result of system's internal dynamics/feedbacks. In particular, the impact of these perturbations occur at slower time scales than the time scale of the system's states [1-2]. Examples of these perturbations are variations in individual growth/death/consumption rates of each species in a population which occur at slower time scales than the time scales of the total population's growth/death/consumption rates [2-4]. From a modeling standpoint, these perturbations are more suitable to be viewed as slow variations in the system's parameters rather than variations in the states. As a result, any change that occurs due to these perturbations will be reflected as change in the nominal system's qualitative properties (phase portrait, number/stability of equilibria).
- In noise-induced regime shifts, perturbations that cause the shifts are viewed as the result of external forces and directly affect the system's states [1-2]. The impacts of these perturbations are therefore assumed to occur at relatively similar time scales as the time scales of the system's states. Examples of these perturbations are annual variation of fish population density in a lake due to seasonal storms, floods or human harvestings [17, 38]. From a modeling stand point, these perturbations are more suitable to be viewed as small variations in the system's states. Moreover, the presence of these perturbations do not cause any change on the nominal system's qualitative properties [1-4].

Due to space limitation, further discussions presented in this paper will be focused on the first type of mechanism, i.e. the bifurcation-induced regime shift. The second mechanism will be presented in another venue.



## II. OBJECTIVE

Consider a dynamical system

$$\dot{x} = f(x, k)$$

whose equilibrium  $x^*$  depend on parameter  $k$ . The resilience of a system under parameter variation can be measured by the distance

$$\gamma = |k_0 - k^*|$$

between the nominal parameter  $k_0$  and the closest critical parameter  $k^*$  at which a bifurcation occur [5]. The quantity  $\gamma$ , often called *distance to closest bifurcation*, is an indicator of how close the system is to a collapse. The computation of  $\gamma$  is generally difficult since the bifurcation set containing  $k^*$  is usually unknown. Prior works [5-8] have used numerical optimization techniques to search for the minimum  $\gamma$  subject to the necessary constraints that are satisfied when a bifurcation occurs at  $k^*$ . These methods, however, are computationally demanding since the search for such a minimum  $\gamma$  requires the computation of the equilibrium  $x^*$  at every iteration.

This paper introduces a convex polynomial optimization technique to obtain a lower bound on the global minimum of  $\gamma$ . Our approach utilizes algebraic geometric methods to reduce the size of the constraints and to avoid the computation of equilibrium  $x^*$  at every iteration of the optimization. The method is illustrated on an example predicting voltage collapse in electrical power networks.

## III. METHODOLOGY

Consider an  $n$ -dimensional polynomial system whose state trajectories  $x(t, x_0)$  satisfy

$$\dot{x}(t) = f(x(t), k),$$

for all  $t \geq 0$  and  $x(0) = x_0$  in which  $f(x(t), k)$  is polynomial in the unknown with coefficient  $\alpha$ . The system's equilibria are vectors in the field of rational functions that are zeros of the right hand side of (1). In other words,  $x^*(\alpha)$  is an equilibrium if [5]:

$$x^*(k) \in \{x \in Q^n(k) | f(x, k) = 0\}$$

Computing the algebraic expression for  $x^*(k)$  in high dimensional systems usually requires the use of symbolic methods [9]. These methods are based on the fact that a set of polynomials generate an *ideal* in the polynomial ring and that the zeros of the system of polynomials are equivalent to the zeros of any Grobner basis of that ideal [9].

Let  $J = \frac{df(x, k)}{dx} \Big|_{x^*}$  be the Jacobian matrix of the system's vector fields evaluated at  $x^*$  with characteristic polynomial

$$p(s) = a_0 s^n + a_1 s^{n-1} + \dots + a_n$$

where the coefficients  $a_i(k)$  are function of the parameter,  $k$ . For  $z = 1, \dots, n$ , let  $\Delta_z$  denotes the z-th Hurwitz determinant of  $p(s)$ . A local bifurcation can be characterized in term of the eigenvalue condition of  $J$  with additional *transversality* conditions. Let  $\Phi_S$  and  $\Phi_H$  be the set of parameters for which a saddle node (also pitchfork and *transcritical*) and Hopf bifurcations occur. It can be shown that these sets are semi-algebraic sets characterized by  $a_i(k)$  and  $\Delta_z$ . One may then denote the parameter set for which at least one type of bifurcation occurs as  $\Phi = \Phi_S \cup \Phi_H$ . Thus, system (1) will not have a bifurcation if  $\Phi$  is empty. Interested readers are referred to reference [10] for detailed method for characterizing the set  $\Phi$ .

#### IV. SIMULATION RESULTS

This example considers a single machine, two-bus generator-line-load model of a power network that was used in [8] to study the voltage collapse problem. The ordinary differential equation model governing the system is given by

$$\dot{\delta} = \frac{1}{M} [P_m - P_{e1}(\delta, V) - D_G \omega]$$

$$\dot{\omega} = \omega - \frac{1}{D_L} [P_{e2}(\delta, V) - P_d]$$

$$\dot{V} = \frac{1}{\tau} [Q_c(\delta, V) - Q_d]$$

The above set of equations is a lumped model of power network consisting three main parts namely (i) the generator part (represented as a second order mechanical system), (ii) the transmission line and (iii) the load part (active and reactive load powers) (cf. Figure 1). One

important subject in power system analysis is the voltage collapse phenomenon that occurs due to variations in the active ( $P_d$ ) and reactive ( $Q_d$ ) load powers. The collapse usually corresponds to voltage instability that occurs when the system's parameters,  $P_d$  and  $Q_d$ , are varied. This instability is characterized by the singularity of the system's Jacobian matrix at some critical parameters. One approach that has been used to predict the onset of a voltage collapse is by computing the minimum distance to instability/bifurcation  $\gamma$  as discussed in Section II.

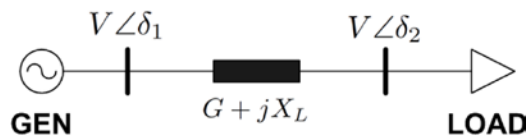

Figure 1. A single machine power network [8].

In this analysis, we consider a nominal equilibrium in which  $\omega = 0$  and choose  $R = 0.1$ ,  $X_L = 0.5$  for the transmission line's parameters [8]. Using this nominal equilibrium, we are interested in characterizing the critical parameter  $k = (P_d, Q_d)$  at which a voltage collapse occurs. We first transform the system model into polynomial functions by using new variables  $x = \sin \delta$  and  $y = \cos \delta$ . Using these new variables, it can be shown that the equilibria of the system are defined by polynomial equations below:

$$\begin{aligned} 0 &= -V_2 G + V G y + V B x - P_d \\ 0 &= -V_2 G - V G x + V B y - Q_d \\ 0 &= x^2 + y^2 - 1 \end{aligned}$$

In addition, it can be shown that the condition for the system's Jacobian matrix to be singular (i.e. has zero determinant) is given by

$$0 = B^2 + G^2 - 2B^2 V y - 2G^2 V y$$

Now, the computation of the minimum distance to instability can be formulated as follows.

$$\begin{aligned}
& \min (P_d^* - P_d^0)^2 + (Q_d^* - Q_d^0)^2 \\
& \text{s.t. } 0 = -V_2 G + V G y + V B x - P_d, \\
& \quad 0 = -V_2 G - V G x + V B y - Q_d, \\
& \quad 0 = x^2 + y^2 - 1, \\
& \quad 0 = B^2 + G^2 - 2B^2 V y - 2G^2 V y, \\
& \quad P_d \geq 0, Q_d \geq 0
\end{aligned}$$

In our simulation, we consider a nominal set of parameters  $k^0 = (0, 0)$ . We used SOSTOOLS [11] to solve the convex relaxation of the above optimization problem and found a minimum  $\gamma = 0.2404$  which corresponds to a set of critical parameters  $k^* = (0.0961, 0.4808)$ . Figure 2 plots the curve of the manifold where instability occurs. The curve plotted in this figure is a certificate which verifies that  $\gamma$  is the shortest distance from the nominal parameter set  $\gamma$  to the bifurcation manifold. The results obtained in our method are exactly the same as that in [8]. The use of convex relaxation method in our approach however required less computational efforts (cf. [10]).

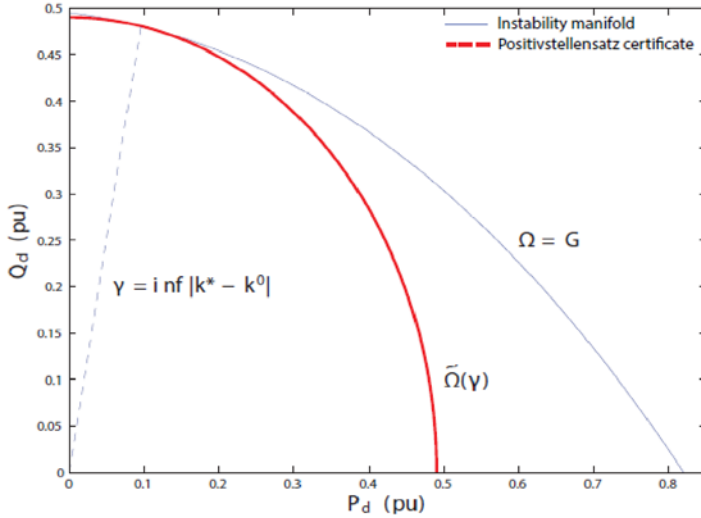

Figure 1. Curves of the instability manifold and lower bound of  $\gamma$ .

## V. CONCLUSION

This paper has presented a method to quantify the resilience of parameter-dependent dynamical systems in presence of the so-called bifurcation-induced regime shift. In particular, the paper showed that the forecast can be formulated as a minimum-distance-to-bifurcation problem whose solution can be obtained using an efficient convex optimization relaxation method. The effectiveness of the proposed framework is illustrated through the study and evaluation of voltage collapse phenomenon in a model of single machine, infinite

bus power system.

## References

- [1] M. Scheffer and S. R. Carpenter, "Catastrophic regime shifts in ecosystems: linking theory to observation," *Trends in Ecology & Evolution*, vol. 18, no. 12, pp. 648–656, 2003.
- [2] M. Scheffer, S. Hopper, M. Meijer, B. Moss, and E. Jeppesen, "Alternative equilibria in shallow lakes," *Trends in Ecology & Evolution*, vol. 8, no. 8, pp. 275–279, 1993.
- [3] C. S. Holling, "Resilience and stability of ecological systems," *Annual Review of Ecology and Systematics*, pp. 1–23, 1973.
- [4] C. S. Holling, "Engineering versus ecological resilience," in *Engineering with Ecological Constraints* (Ed. P. Schulze), pp. 31–44. National Academy Press, 1996.
- [5] Y. A. Kuznetsov. *Elements of Applied Bifurcation Theory*. Springer-Verlag New York, Inc., 1998.
- [6] I. Dobson, "Computing a closest bifurcation instability in multidimensional parameter space," *Journal of Nonlinear Science*, vol. 3, no. 1, pp. 307–327, 1993.
- [7] I. Dobson, "Distance to bifurcation in multidimensional parameter space: Margin sensitivity and closest bifurcations," in *Bifurcation Control*, pp. 49–66. Springer, 2003.
- [8] C. A. Canizares. Calculating optimal system parameters to maximize the distance to saddle-node bifurcations. *Circuits and Systems I: Fundamental Theory and Applications*, IEEE Transactions on, 45(3):225–237, 1998.
- [9] W. Decker and C. Lossen. *Computing in Algebraic Geometry*, volume 16 of *Algorithms and Computation in Mathematics*. Springer Verlag, 2006.
- [10] T.A. Tamba, *Forecasting Regime Shifts in Nonlinear Dynamical Processes*, PhD Dissertation, Department of Electrical Engineering, University of Notre Dame, USA, August 2015.
- [11] S. Prajna, A. Papachristodoulou, and P. Parrilo, "Introducing sostools: A general purpose sum of squares programming solver," *Proceedings of the 41st IEEE Conference on Decision and Control*, pp. 741–746, 2002.

## **Cross Border Energy Cooperation: A structural energy security approach in Asia addressing SDG**

**Name of Author:** S.M. Zahid Hasan,

**Institution of Author:** GIZ/ Bangladesh Power Development Board,

**Email:** sumon233@yahoo.com

### **Key Words**

Energy, regional, security, cooperation, surplus, deficit, bilateral, resource, political

### **Abstract**

At present Asian continent is an important part of this world with its huge population base and robust economic growth that is facing several security challenges. Energy Security is an important issue among those and been concern for majority of the countries in Asia as it significantly pertinent with development, economy, large scale investment, political threats and affordable tariff rates etc. The Energy Sector has not been able to keep pace with the growth and has been continuously experiencing chronic supply deficit, infrastructural shortfalls and poor quality of services due to several social, political and economic differences. Regional cooperation to ensures greater supply security and reliability, to reduce the reserves needed for meeting peak demands, lower costs through economies of scale, to increase diversification of primary sources of energy and to contribute to overall system efficiency is therefore are essential aspects determined by numbers of think tanks. While success stories of regional energy trading in Europe, South East Asia is observed functional, trading of energy is practically non-existent in South Asia although some exception of small pockets of bilateral power exchanges between Nepal, Bhutan, Bangladesh and India are found. On the other hand, in Pakistan and Nepal the energy sector is suffering from a growing “circular debt” problem. In this regard, a study of the Greater Mekong Sub-region in Southeast Asia suggests that regional cooperation in energy could reduce energy costs by nearly 20%, for a saving of \$200 billion during 2005–2025.

This study has tried to examine and analyze energy scenario of Asian countries prioritizing South Asia to identify the factors to be followed to achieve regional energy cooperation in a meaningful structure which are based on primary resource sharing (hydro, renewable, Natural gas, Coal), Transit (for Oil, LNG, gas), infrastructure and data/information sharing, seasonal/peak-off peak exchange of power, joint Investment, capacity building of regional organizations and institutions, easy connectivity to utility grids, and of course political alignment among the countries. It also attempted to identify the potential, opportunity, challenges of regional energy cooperation and steps to be taken at foreign ministry level to get proactive role to building evolving energy strategies in Asian countries. As part of this it has examined the existing state of energy cooperation in Asia (SAARC, ASEAN, BIMSTEC),

reviewed barriers to cross-border energy cooperation as well as trade through literature review Case Studies (Germany, Japan, India, Bhutan, Nepal and Bangladesh) etc.

Finally, it is revealed that regional energy cooperation can use 'idle' infrastructure, liquidity, transit routes, and knowledge capital. Countries involved in this cooperation will have chances to be benefited. Long term and short term strategies to achieve energy security is highly recommendable through timely investment that meets environmental needs and focuses on the ability of the energy system to react promptly to sudden demand changes. Priority must be given to improving physical connectivity and building institutional linkages to building blocks of confidence for a regional energy cooperation platform to help link 'energy-surplus' and 'energy-deficit' countries. This would facilitate joint investments by energy buyers and sellers from both public and private sectors in improving intra-regional energy transport as well as the development, commercialization and dissemination of energy-efficient technologies addressing SDG 7, 9 and 12.

## 1. Introduction

Regional energy cooperation presents a golden opportunity for involved countries to tackle challenges and obstacles towards economic progress, particularly in the energy sector. Examples of successful collaboration are observed in different regions of the world predominantly in sharing electricity generation using cross-border transmission interconnections. Such as, Germany imports power from France at western border whereas it exports power to Denmark at northern end. Germany is doing so because of both the cases are cost effective and convenient/efficient for their Power System. "Estimates suggest that in Europe, electricity system interconnection has resulted in a 7%–10% reduction in generation capacity costs. Similar cooperation within the United States has been estimated to bring benefits in the order of \$20 billion. A study of the Greater Mekong Sub-region in Southeast Asia suggests that regional cooperation in energy could reduce energy costs by nearly 20%, for a saving of \$200 billion during 2005–2025".<sup>[1]</sup>

We know, energy is a strategic commodity. On the other hand, energy security can be defined as the uninterrupted supply of energy from available sources at an affordable price (IEA, 2014). Energy Security has always been an important factor for all the countries in the world, as with modernization, the use of energy has been increasing rapidly and people's life and national economy becoming dependent on the usage of energy. "Every 1% growth of GDP is estimated to lead to a growth of 1.4% demand for electricity in a typical developing country. For a 5-6% typical annual economic rate of growth this would imply a need for close to 7-8% growth in electricity supply."<sup>[2]</sup> So, to maintain a secured future, different long term and short term initiatives are being taken in the energy sector all over the world. While long term energy security is highly related to alignment with country specific policy, timely investment in supplying energy in line with economic development and energy strategy that meets environmental needs. Whereas, short term energy security focuses on the ability of the energy system that reacts promptly to do needful meeting-up sudden demand of energy or crises management of energy. Cross border energy cooperation in regional approach can address both short and long term energy security. Energy security drives the growth of a country by facilitating the production of a country.

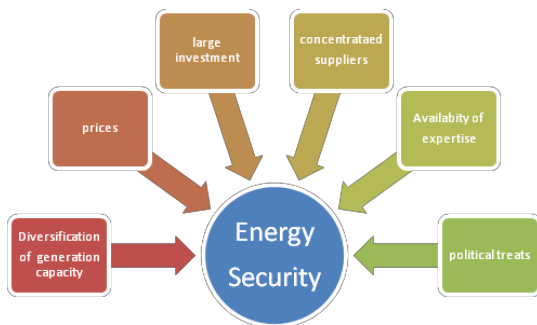
**Fig-01 Energy Security**

Source: Energy Security: Trends and Challenges: Bangladesh Economic Update, 2014, Page-5

[1] ADB, Philippines (2012) 'Energy trade in South Asia: Opportunities and challenges, ISBN 978-92-9092-631-3.

[2] 6<sup>th</sup> five year plan, Bangladesh, 2011, Page 123

### 1.1 Regional Energy Cooperation to meet UN Sustainable Development Goals

On 25<sup>th</sup> September 2015, the 193 countries of the UN General Assembly adopted the 2030 Development Agenda<sup>[3]</sup> and introduced the term 'Global Goals' which are intended to help communicate the agreed Sustainable Development Goals (SDGs) to a wider constituency. Among them energy pertinent Goals, Goal-7, 9 and 12 defines sustainable characteristics of energy, its importance and role to achieve sustainable infrastructure, socio-economic development etc. and those are stated below;

- GOAL 7: Ensure access to affordable, reliable, sustainable and modern energy for all
- GOAL 9: Build resilient infrastructure, promote inclusive and sustainable industrialization and foster innovation
- GOAL12: Ensure sustainable consumption and production patterns

Under SDG 7, 9 and 12, the more specific sub-goals are mentioned those are mentioned here respectively.

7.a By 2030, enhance international cooperation to facilitate access to clean energy research and technology, including renewable energy, energy efficiency and advanced and cleaner fossil-fuel technology, and promote investment in energy infrastructure and clean energy technology

9.1 Develop quality, reliable, sustainable and resilient infrastructure, including regional and trans border infrastructure, to support economic development and human well-being, with a focus on affordable and equitable access for all

12.2 By 2030, achieve the sustainable management and efficient use of natural resources<sup>[4]</sup>

### 1.2 Background Statement:

Asia has experienced a long period of robust economic growth compared to other continents for more than two decades. Although Asian continent is an important part of this world with its huge population base, more than 200 million people still live in slums in poor conditions,



and half a billion people are without electricity (MDG Report 2012). Energy Security is an important issue for majority of the countries in Asia as it significantly pertinent with development, economy, large scale investment, political threats and affordable tariff rates etc. While developed or transitional countries in Europe, Americas, Africa and in South East Asian countries adopted 'regional concept' in their energy planning, projects to get optimum benefits whereas other parts of the world is far behind. In addition, Japan, South Korea and China also are co-operating each other by means of energy cooperation. In Asian Continent South Asian countries although have taken some initiatives recently but those are still in premature stage. The energy sector in Asia especially South Asia has not been able to keep pace with vibrant growth, not able to provide energy security and has been continuously experiencing chronic problems of supply deficit and poor quality of services due to lack of trust, several social, political and economic differences. Towards sustainable development huge infrastructure gaps, extreme forms of social exclusion and increase inequality are the major challenges of this region. This also caused an adverse impact on economic and social development.

The cross border energy cooperation among regional countries based on infrastructure/resource sharing, capacity building and harmonization of policies and regulations are significantly visible in

[3] <http://undocs.org/A/68/970>, <http://www.globalissues.org/article/26/poverty-facts-and-stats>

[4] [https://en.wikipedia.org/wiki/Sustainable\\_Development\\_Goals](https://en.wikipedia.org/wiki/Sustainable_Development_Goals)

Europe, Africa and Americas as its economic and technical advantages are of many. It ensures greater supply security, reduces the dependency on reserves needed for fulfillment of peak demands, comparatively lower costs, and increases diversification of primary sources of energy. Moreover, cross border energy cooperation contributes to overall system efficiency as a whole. Regional integration and energy trade in Asian region specifically in South Asia lags significantly behind most of the world although some bilateral rather than tripartite initiatives now-a-days are observed among India, Bangladesh, Bhutan and Nepal.

**1.3 Objective of the Study:** The main objective of this study is to find out the ways that can be followed by candidate countries to establish cross border energy cooperation by means of region based arrangements, treaties etc.

This study mentioned in what approaches and steps cross border energy cooperation can be established, to be functional in a sustainable way and what are the priority areas for such cooperation in case of Asian continent. Moreover, it is also addressed here that potentialities of regional energy cooperation options in Asia especially in South Asia considering opportunities and challenges.

**1.4 Methodology:** This study considered secondary data sources through Literature review, regional initiatives (SAARC, ASEAN, BIMSTEC) related information gathering, Case Studies (Germany, Japan, India, Bhutan) and internet sources.

**1.5 Limitation of the study:** The scope of the study is divided into three contexts: resources, technical and assumption based approaches. As discussed limited energy resources here, the study mostly emphasized electricity and natural gas transmission as well

as resource sharing mainly hydro potential and on the basis of three indicators i.e. availability, affordability and sources of energy. Its main focus was on regional energy cooperation in the South Asian region only.

## 2. Energy Scenario in Asia as a whole

We know, major energy consuming countries are located in the Asian region and among them China, India, Japan and South Korea stand for 1<sup>st</sup>, 2<sup>nd</sup>, 4<sup>th</sup> and 8<sup>th</sup> position respectively. Only China, Japan and South Korea are consuming around 40% of total energy in this world. Indonesia, Malaysia, Myanmar and Vietnam are the important energy exporting countries in the Asian region. As it is the most energy scarce region of the world, 22.8% energy consumed in Asia was met by importing energy from the rest of the world.

**Table-1: Fossilfuels production, consumption, balance & distribution of Primary Fuel Consumption in Different Regions in 2013 (in MTOE)**

Regions	Fossilfuels			Total Primary Consumption	Percent Non-Renewable	Percent of Total
	Fossil Prod.	Fossil Con.	Fossil Balan.			
Asia Pacific	3507.80	4686.70	-1178.90	5151.50	90.98	40.47
Europe & Eurasia	2217.30	2345.60	-128.30	2925.30	80.18	22.98
North America	2144.20	2351.20	-207.00	2786.70	84.37	21.89
Middle-East	1841.40	778.50	1062.90	785.30	99.13	6.17
South & Central America	595.10	492.60	102.50	673.50	73.14	5.29
Africa	749.60	377.50	372.10	408.10	92.50	3.21
Total World	11055.40	11032.10	23.30	12730.40	86.66	100.00

Source: BP 2014

**Energy –Economy Nexus in Regional Continents:** Per capita commercial energy consumption versus gross national income of Asia countries are mentioned below;

**Fig-2 : Per Capita Commercial Energy Consumption versus Per Capita GNI in 2012**

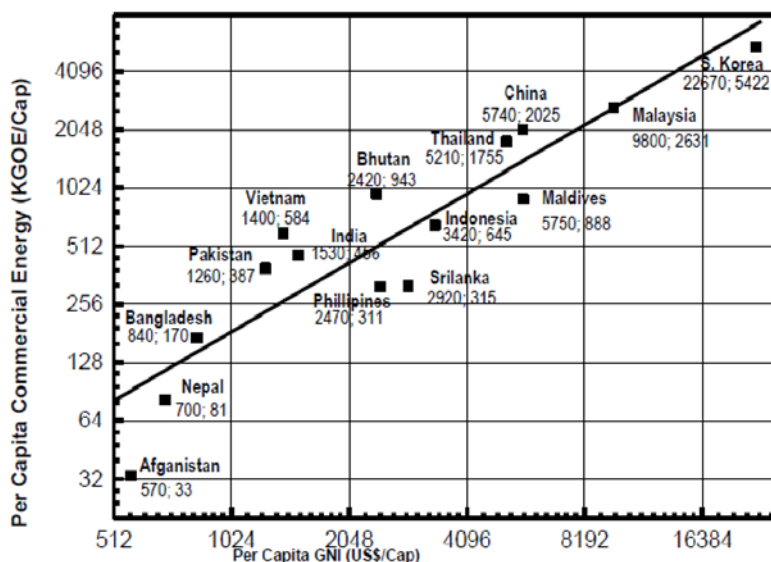

Source: Dr. M. Nurul Islam, PPP Slide-10, MNI-IEB Asia Pacific, IEB, Dhaka (2015)

In Asian region Iran, Qatar, KSA, China, Indonesia and Malaysia are the major gas reserve base countries. Whereas, in South Asia India and Pakistan have moderate reserves.

**Table-2: Proven Natural Gas reserves of South Asian Countries and comparisons with selected other countries**

Country	Natural gas	
	Reserves (trillion cubic feet)	R/P ratio (years)
Afghanistan	NA	NA
Bangladesh^	15.4	30.7
Bhutan	0	NM
India	38.9	36.2
Maldives	0	NM
Nepal	0	NM
Pakistan	34.0	32.2
Sri Lanka	0	NM
Australia	89.0	67.9
China	83.0	47.0
Indonesia	97.4	36.3
Iran	944.0	*
Japan	0	NM
Kazakhstan	106.0	*
Malaysia	87.5	41.4
Myanmar	17.7	38.5
Qatar	910.0	*
Saudi Arabia	244.0	99.3
Thailand	12.5	16.5

**Energy Scenario in South Asia:** South Asian region is vital part of this world with its continuous and rapid growing economy and huge population base. According to the United Nations geographical region classification Southern Asia comprises the countries of Afghanistan, Bangladesh, Bhutan, India, Iran, Maldives, Nepal, Pakistan, and Sri Lanka. By other definitions and interpretations Myanmar is also sometimes included in the region of South Asia. As one of the most populous regions of the world, it has a relatively small land mass and a high poverty level. While growing populations have kept the per capita income in the countries of South Asia stubbornly below the world average, the energy security situation is especially acute for South Asian nations, where energy sectors must typically grow by 2-3% over the GDP growth rate of 5.69%<sup>[5]</sup> simply to sustain the economy. So, each country in the region addresses critical energy concerns align with economic expansion plans as well as her ability to bring underserved local populations onto the grid. Therefore, to meet the growing aspirations of the people and economies of South Asian, each of the countries are under immense social and political pressure to secure reliable, sustainable, and reasonably priced energy supplies to meet the demand for energy. “South Asian countries are highly dependent on imported crude oil and petroleum products. The imports range from 25% of commercial energy consumption in the case of Bhutan to 100% in the case of Maldives.”<sup>[6]</sup> The recent volatility and sharp decrease in world oil prices has placed an unexpected and enormous gain on foreign exchange reserves such as in Bangladesh, India, Sri-Lanka and Pakistan. While countries like Nepal and Bhutan have no remarkable issues due to negligible amount of crude oil uses in these countries. While success stories of regional energy trading in Europe, South East Asia is observed functional, trading of energy is practically non-existent in South Asia although some exception of small pockets of bilateral power exchanges between Nepal, Bhutan, Bangladesh and India are found. On the other hand, in Pakistan and Nepal the energy sector is suffering from a growing “circular debt” problem.

Fig-3: Per capita energy consumption in different countries in South Asia

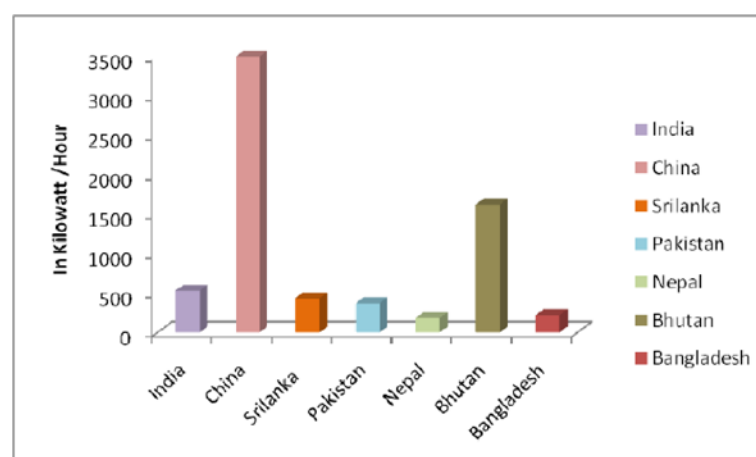

Source: CIA World Fact Book, 2013

In this region, the potential and reserve for primary energy resources comes from a wide variety of options such as biomass, solar, wind, natural gas, hydro, mining oil and coal etc. The natural gas reserves in Bangladesh, India, Myanmar and Pakistan are considerable but

among them mine based energy sources are seen not sustainable as these are advancing in exhaustible state. Therefore, experts are seen these sources not as a dependable source for long term planning. Though India and Pakistan have remarkable coal reserves, Bangladesh has limited coal

[5] <http://www.tradingeconomics.com/south-asia/gdp-per-capita-growth-annual-percent-wb-data.html>

[6] [http://pdf.usaid.gov/pdf\\_docs/Pnads866.pdf](http://pdf.usaid.gov/pdf_docs/Pnads866.pdf), Page-8

reserves and plans to develop them slowly; although its one large open-cut project in Phulbari has been shelved just before beginning production due to mass demonstrations about the displacement of local communities.<sup>[7]</sup>

**Table-3: Production of Energy in South Asia (2003-2005)**

<u>Country</u>	<u>Oil</u>	<u>Nat. Gas</u>	<u>Coal</u>	<u>Hydro</u>	<u>Nuclear</u>	<u>Total Coml.</u>	<u>Biomass</u>
	(million tonnes oil equivalent)						
Afghanistan	0.0	0.2	*	*	0.0	0.2	6.9
Bangladesh	4.0	12.8	0.4	0.3	0.0	17.5	16.6
Bhutan	0.0	0.0	*	0.4	0.0	0.4	0.3
India	115.7	33.0	212.9	21.7	4.0	387.3	106.0
Maldives	0.0	0.0	0.0	0.0	0.0	0.0	0.2
Nepal	0.0	0.0	*	0.1	0.0	0.1	7.4
Pakistan	17.4	26.9	4.1	6.9	0.6	55.9	23.4
Sri Lanka	0.0	0.0	0.0	0.8	0.0	0.8	3.6

\*= small amount.

Source: US AID

The electricity supply and demand scenario in South Asia is mentioned in the Table-4.

Table-4: Electricity Supply and Demand in SAARC Countries (2013/14):

	Installed Generation Capacity (MW)	Peak Demand (MW)	Generation (GWh)	Demand (GWh)
Afghanistan <sup>a</sup>	620	700	880	3890
Bangladesh	9821	9268	42195	36233
Bhutan <sup>a</sup>	1510	282	6750	1640
India	237742	129815	957734	802567
Maldives	141	N/A	290	270
Nepal	787	1200	3558	3448
Pakistan <sup>a</sup>	22860	23953	92860	76860
Sri Lanka	3362	2164	11962	10632

<sup>a</sup>Data in the year 2011/12

Source: Priyantha ....and P. N. Fernando (2015), 'cross-border power trading in South Asia: A Techno Economic Rationale', ADB South Asia working paper series-38, Page-10

**Hydro Power Potential in the Region:** Hydropower potential represents one of the largest energy resources in the region, and India's potential is 301,000 MW, Bhutan 50,000 MW, Nepal 42,915 MW, Pakistan 40,000 MW, Sri Lanka 2,000 MW, and Bangladesh 775 MW, totaling 437,000MW of which only 9% has been exploited. The hydro power potential candidate areas in South Asia, India and Bhutan are shown below in Fig 4-6 as per JICA Study.

[7] Lahiri-Dutt, Kuntala. "Energy Resources: Will they be the last frontier in South Asia?", Research School of Pacific and Asian Studies, ANU

**Fig 4-6: Hydro Power Candidate Areas in South Asia**



Source: JICA

Japan International Cooperation Agency (JICA) has assessed and figured out hydro power potential in South Asia specifically in India, Bhutan, Nepal and Myanmar and those locations are shown in Fig- 4-6. These countries have big untapped potential of hydro energy and that could be explored by joint regional initiatives/investment hydro power station construction project.

Potential Site in Meghalaya State (2/2)

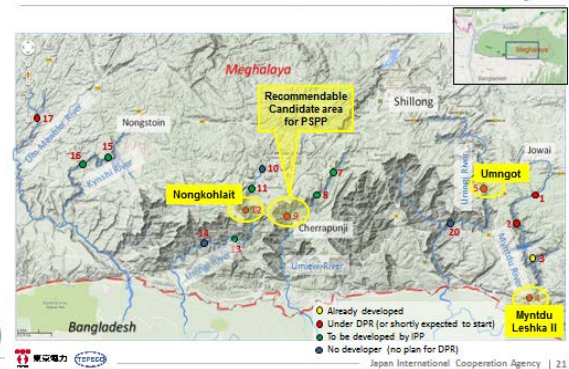

Hydropower Project Plan in Bhutan (2/2)

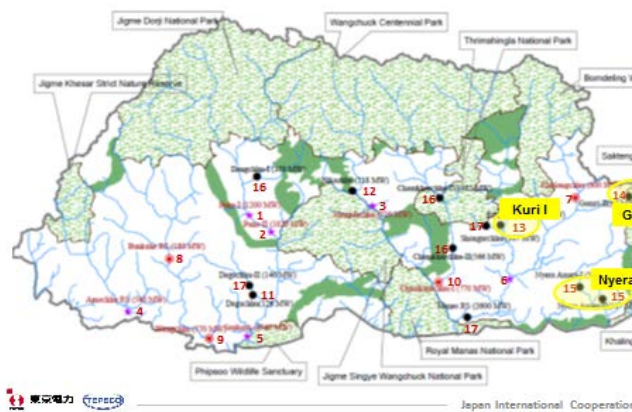

**Myanmar’s transit to energy transportation towards China:** Myanmar and China are approaching to have two routed pipelines for carrying gas and oil to China using Myanmar’s land and Bay of Bengal. This pipeline will bring 12 million MTs of Crude oil and 12 billion cubic meters of gas to China. This project will be a big example of regional energy cooperation using the advantage of geographical position and transit route.

Figure-7: Myanmar -China natural gas and oil trade (onshore route)

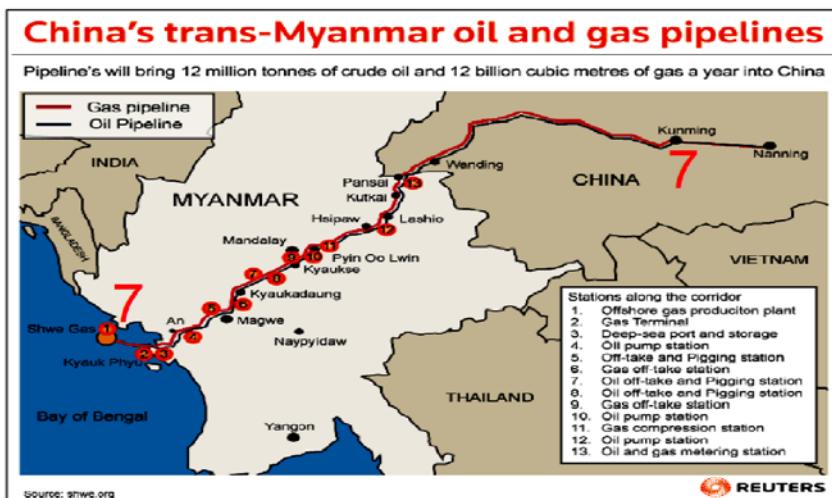

Source: shwe.org

### Opportunities identified for cross border energy trade by think tanks:

1. Central Asia-Afghanistan Bilateral Electricity Trade
2. Iran-Pakistan Bilateral Electricity Trade
3. Pakistan-India and Pakistan-Afghanistan Bilateral Electricity Trade
4. Central Asia-South Asia Multilateral Electricity Trade
5. Turkmenistan-Afghanistan-Pakistan-India Natural gas Trade via pipeline
6. Iran-Pakistan-India Natural gas Trade via pipeline
7. Qatar-Pakistan-India Submarine Gas Pipeline
8. India-Srilanka Bilateral Electricity Trade
9. Nepal-India Bilateral Electricity Trade
10. Bhutan-India Bilateral Electricity Trade
11. Bangladesh-India Bilateral Electricity Trade
12. Bangladesh –Qatar LNG Import ((MOU Signed)
13. Bangladesh, India, Bhutan, Nepal Multi-lateral Electricity Trade
14. Myanmar-India-Bangladesh India (on shore route)
15. Myanmar- Bangladesh India (on shore route)
16. Myanmar-India (off shore route)
17. Myanmar-China Natural Gas Trade (on shore route)
18. Myanmar-Bangladesh Electricity Trade (MOU Signed)
19. Myanmar-India Bilateral Electricity trade
20. Myanmar China Bilateral Petroleum trade (on shore route)
21. Bangladesh –India Petroleum Import
22. Bangladesh-Indonesia Coal Import

Source: Adapted from the PP Presentation of Dr. M. Islam, MNI-IEB Asia Pacific, Dhaka (2015)

**Prospect of Regional Electricity Grid across South Asia:** Prospect of regional grid across South Asia based on a common grid system and multi-nation basis is possible if political stability in Central Asia, Afghanistan, Pakistan and India could be achieved. Moreover, there is a huge prospect of bilateral electricity transboundary cooperation among partner countries exist those are shown in the below figure.

**Fig-8: Proposed Regional Electricity Grid in South Asia**

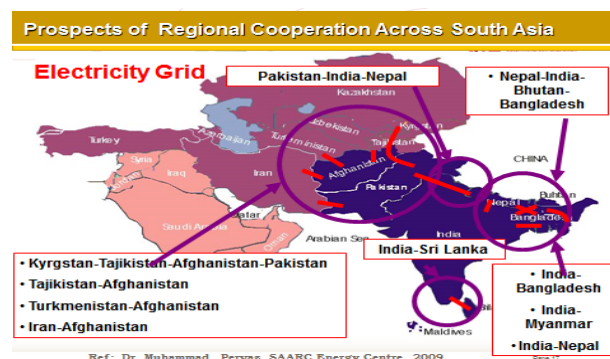



Development Bank or donor agencies are showing interest to finance bilateral cross border regional grid for electricity trade. In June 2011 – The World Bank approved a US\$ 99 million package for the Nepal-India Electricity Transmission and Trade Project (NIETTP) to assist efforts of the Government of Nepal to mitigate a national energy crisis.<sup>[8]</sup>

Furthermore, a study by USAID conducted by Nexant Inc. suggested a conceptual “Energy Ring” to energy flow as shown in Figure-9. As per study recommendation, the SAARC Energy Center can examine and facilitate the implementation by identifying the current obstacles to developing energy flows in the region by advocating the quantitative and qualitative benefits that could accrue to the individual countries. The individual components of the “Energy Ring” as shown in Figure-10 which separates out the components showing flows of electricity, natural gas, and energy technology.

**Fig-9: Illustrative “Energy Ring” in South Asia**

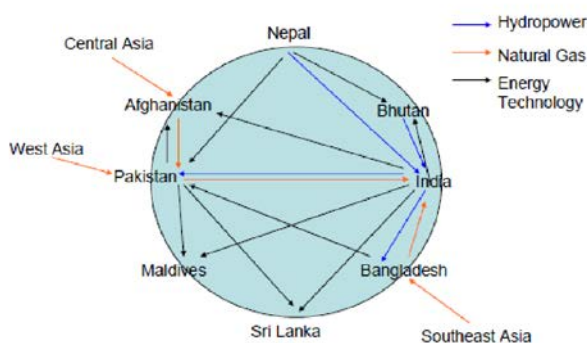

[8] <http://www.worldbank.org/en/news/press-release/2011/06/21/world-bank-supports-cross-border-energy-cooperation-between-india-and-nepal>

**Fig-10: Components of the “Energy Ring” in South Asia**

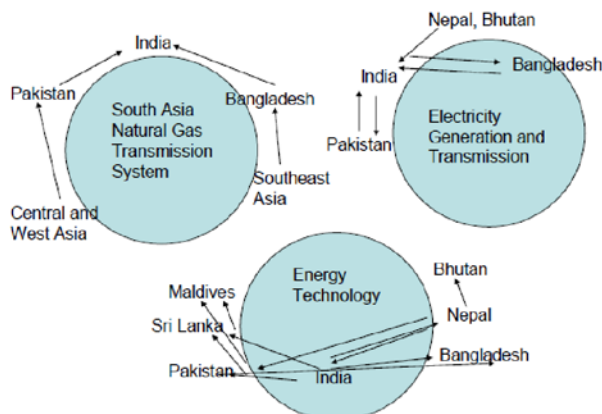

Source: USAID (August 2006) by Nexant, Inc. under Contract No. 386-C-00-03-00135-00

**2.2 SAARC Initiative for Energy Cooperation:** To facilitate the objective of this region to progress towards better economy, South Asian Association for Regional Cooperation (SAARC) was formed in 1985. But, due to some lack of trust between the member states and political

Table-5: Existing and some proposed cross border electricity Trade Arrangement in South Asia

<i>Participants</i>	<i>Cross-border electricity trade</i>
<i>India – Nepal</i>	Nepal imported 793GWh electricity in 2013 from India over multiple interconnections.
<i>India-Bhutan</i>	Electricity import from Bhutan to India was 5556 GWh in 2013-14 (4627 GWh in 2012-13) from Hydro power stations at Tala, Chukha and Kurichu with a total export led capacity of 1416 MW. As per an umbrella agreement between the two countries, India assures a minimum of 5000 MWelectricity import by 2020.
<i>Pakistan-Iran</i>	Pakistan imported 419 GWh electricity in 2014 from Iran, up from 375 GWh in the previous year.
<i>Afghanistan-Central Asia</i>	Import of 2,246.2 GWh electricity from Iran, Uzbekistan, Turkmenistan, and Tajikistan in 2011. CASA-1000 expected to enhance this trade.
<i>Pakistan-India</i>	Pakistan has submitted a draft MoU to India on importing electricity using a 1200 MW interconnection. There are also possibilities of CASA to be extended to India.
<i>India-Sri Lanka</i>	Feasibility studies for a 400-kV India-Sri Lanka have been conducted to support import of up to 1000 MW electricity from India.
<i>India-Bangladesh</i>	In 2013, power systems of India and Bangladesh were interconnected through a HVDC line that can support electricity export of up to 500 MW (expandable to 1000 MW in future) from India to Bangladesh based on negotiated price and market based price.

Source: Anoop Singh. Development Research Group, WB Group (June 2015), Page-7

dilemma, SAARC has never flourished to its full potential. Through building mutual trust and understanding it has a big scope to create a strong regional cooperation which includes bilateral and multilateral energy trade and a generalized energy policy which can provide a guiding principle for energy security in the future. With the present and projected scenario of energy reserve, production and consumption pattern of the countries, it can be seen that there is a dire need of cooperation among the countries. As a symbol of cooperation to fulfill these need Energy ministers in SAARC nations signed SAARC Inter-Governmental Framework Agreement (IFA) for Energy (Electricity) Cooperation to ease electricity crisis in the region. The agreement would allow the SAARC nations buying and selling entities to negotiate the terms, conditions, payment security mechanism and tenure of their power purchase agreements as normal commercial agreements.

**2.3 Bangladesh and Cross Border Energy Cooperation:** Government of Bangladesh has taken serious initiatives to broaden hands for regional energy cooperation among regional/partner countries through treaty, bilateral or multi-lateral agreements/MOU. Meanwhile, Sector Leader Workshop 2015 recommended that Bangladesh should harness 10000 MW power from regional cooperation by 2030. A JICA Study recently has found that Bangladesh can import 8,000-megawatt (MW) power, especially hydropower, from three BBIN countries -Bhutan, India, and Nepal -by the year 2035.<sup>[9]</sup> Recently Bangladesh has made some good progress for cross border energy cooperation listed below;

[9] JICA for jt venture investment to source power from BBIN states; <http://www.thefinancialexpress-bd.com/2015/08/22/104896/print>

- ❖ MoU signed for Power sector Cooperation on 11.01.2010.
- ❖ Framework Agreement signed in 16.9.2011.
- ❖ Bangladesh importing 500 MW of power from India from 05.10.2013
- ❖ 1320 MW Maitree Super Thermal Power Project in Rampal
- ❖ Import 100 MW Power from Tripura by December 2015.
- ❖ Import of oil from petroleum from India and joint initiatives of refining oil in Chittagong
- ❖ Additional 500MW import Through Bheramara- Baharampur grid by June, 2017
- ❖ Detail Project Report (DPR) has been prepared to construct 800 KV Bipole DC transmission Line from Rangia-Rowta through Barapukuria to Mugaffar Nagar, Bihar for transmitting 6500-7000 MW.
- ❖ Bangladesh Intends to import about 2000 MW from this Line.

**Bangladesh –India Power/Energy Exchange:** The first interconnector with 400 kV Double Circuit Transmission Line between Bahrampur, India and Bheramara, Bangladesh was inaugurated in 2014 with a capacity of 500 MW power transfer. It has been so successful that it is now planned that capacity will be doubled by 2017-2019. Government Electricity Planners to date have identified three more interconnection possibilities with India for bilateral power trade those are as following:

- (a) Rangia, India – Barapukuria, Bangladesh Interconnection (initial potential: 4000 MW)
- (b) Silchar, India – Fenchuganj, Bangladesh Interconnection (initial potential: 500 MW)
- (c) Tripura, India – Comilla, Bangladesh Interconnection (initial potential: 500 MW)

Another Interconnection point has been identified between Myanmar and Chittagong, Bangladesh with minimum potential of 500 MW power trade. Moreover, Bangladesh is now getting 100 MW power from Palatana Power Station, Tripura, India through Tripura-Comilla transmission line. At present Tripura Govt. is agreed to give another 100 MW power to Bangladesh. Recently discussion is going on with Myanmar to import power from them.

**Fig-11: Prospective Electricity grid cross border connection of Bangladesh**

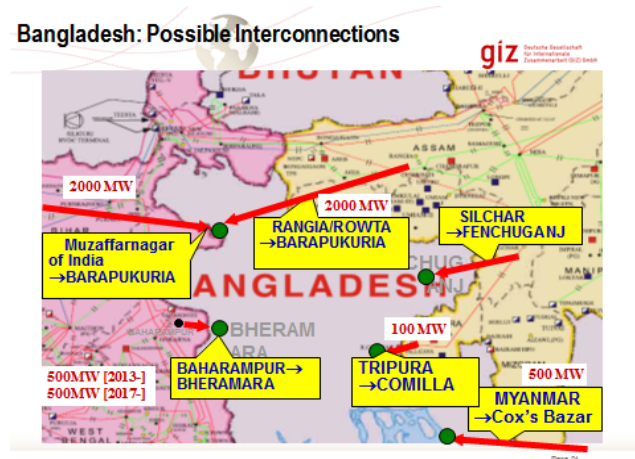

Source: Power Division, MPEMR, Bangladesh

**Ongoing Discussions on Cross Border Energy Cooperation:** Bangladesh Government has received proposals in recent dates for energy cooperation as following;

- 500 MW from GMR
- 1200 MW from Reliance Power Company Ltd.
- Feasibility study started to construct 800 KV Bipole DC transmission line from Rangia-Rowta to Barapukuria to Mugaffarpur, Bihar for transmitting 6500-7000 MW. Bangladesh intends to import about 2000 MW from this proposed line.
- Bangladesh-Myanmar exchange programme on Gas/Power Trade

It is to be noted here that expert opinions relevant to power import from India limits Power import through the Indian grid should be within 15% of the total supply capacity in Bangladesh and Power import from a single receiving point should be within 10% of the maximum demand in Bangladesh for concerning grid stability. To avoid grid accidents DC-link is preferable for Mutual interference.<sup>[10]</sup>

#### **2.4 Some Remarkable others Cross Border Energy initiatives in Asia:**

**Energy Cooperation through BIMSTEC:** In order to create a link between ASEAN and SAARC, Bay of Bengal Initiative for Multi-Sectoral Technical and Economic Cooperation (BIMSTEC) was formally launched on 31 July 2004. Bangladesh, India, Myanmar, Sri Lanka, Thailand, Bhutan and Nepal are involving in this group in South Asia and South East Asia. One of the vital sectors of these group agendas is Energy. Member states of the BIMSTEC have reached a consensus to sign a Memorandum of Understanding (MoU) to exchange electricity among them. "The proposed MoU will provide a broad framework for the member countries to cooperate towards the implementation of grid interconnection for the trade in electricity based on bilateral building blocks with a view to promoting rational and optimal power transmission in the BIMSTEC region. It also added that the BIMSTEC trans-power exchange and development projects will be implemented through strengthening of bilateral and intra-regional cooperation within the framework of respective member countries' environmental and electricity laws and regulations. According to the MoU, the member states will coordinate and cooperate in the planning and operation of interconnected systems to optimize costs and maintain satisfactory security to provide reliable, secure and economic electricity supply to the member countries. The issue of imposing import, export, or transit fee, duty, tax or other government charges on construction, operation and maintenance of the BIMSTEC grid interconnection will be mutually agreed upon under the MoU."

**ASEAN: Cross border energy Cooperation:** "ASEAN has been active in energy cooperation, in particular in its institutionalization. At several levels of

[10] JICA Study

Fig-12: ASEAN Energy Network



Source: (Ahmed and Sarkar, 'Energy Cooperation in South Asia: Prospects and Challenges', Page-14)

Government and depending on the issue (fossil fuels, renewable energy, power utilities, regional policy and planning), the member countries are organized and meet on an annual basis, while their reports are made available to the general public. For both the gas pipeline and a power grid, an ASEAN Master Plan was completed in 2000 and 2003 respectively (The 22<sup>nd</sup> ASEAN Ministers on Energy Meeting 2004). Four power grid interconnections are already in place in Southeast Asia: Peninsular Malaysia–Singapore, Thailand–Peninsular Malaysia, Vietnam–Cambodia, Thailand–Cambodia). ASEAN's strategy is to "encourage interconnections of 15 identified projects, first on cross-border bilateral terms, then gradually expanding to a sub-regional basis and, finally to a totally integrated Southeast Asian power grid system." There are four ongoing interconnection projects and an additional 11 projects are planned for interconnection by 2015." (ASEAN Centre for Energy 2009)

**Four Borders Project: Reliability Improvement and Power Transfer in South Asia:** During 2001–2002, under the USAID sponsored SARI/Energy Programme, Nexant conducted a study on the "Four Borders Project: Reliability Improvement and Power Transfer in South Asia", which suggested connecting Siliguri (India) to Anarmani (Nepal) and Thakurgaon (Bangladesh) initially by 132 kV lines, capable of being upgraded to 220 kV as the volume of interchange increases. It also suggested the alternative of connecting Purnea (India) to Duhabi (Nepal) and Ishurdi (Bangladesh). Further connections are possible from Chhukha (Bhutan) to Siliguri and then on to Purnea. The cross-border flows would be around 500 MW and these would represent a relatively low-cost initiation of power trade, which could be extended later.

**Figure 13: Four Borders Project**



Source: (Ahmed and Sarkar, 'Energy Cooperation in South Asia: Prospects and Challenges', Page-17)

### 2.5 Regional Energy Cooperation in other continent:

**European Energy Cooperation Pillar:** The European Union's integration can be seen as the mother of all regional agreements. "While the EU mainly evolved out of the regional cooperation on coal, steel and nuclear energy under the 1951 European Coal and Steel Community (ECSC) and European Atomic Energy Community (EURATOM) treaties, energy policy has never become a supranational portfolio. Energy cooperation at the intergovernmental level, however, has deepened integration and always been supported by EU institutions. Gas Pipelines like the Nabucco (connecting Europe to the Middle East through Turkey) or North-Stream projects (connecting to Russia through the Baltic) have an inherently European character for importing gas from the EU's eastern and southern neighbors. Before 2007, the EU was divided into regional transmission organizations, coordinating national transmission system operators. Synchronization of the regional grids happened in 2007 (**Bower 2003**). An analysis of the role played by energy policy in the overall European integration process will further add to the theoretical approach to regional cooperation."

### 2.6 Regional institution in Asia:

**SAARC Energy Centre (SEC):** Though Energy is not a priority agenda of SAARC, the creation of SAARC Energy Centre (SEC) came into picture after the Dhaka Declaration in 2005. The SAARC Member States have agreed to promote development of energy resources, including hydropower; and energy trade in the region; to develop renewable and alternative energy resources; and to promote energy efficiency and conservation in the region. SEC established on 1<sup>st</sup> March 2006 in Islamabad. SAARC energy cooperation program provides a major substantive element for economic development of South Asia. SEC is converting energy challenges into opportunities for overall development of the region. It acts as a platform involving officials, experts, academics, environmentalists and NGOs to tap potentials of cooperation in energy sector including development as well as inclusion of renewable and alternative energy, promoting technology transfer, knowledge management,

energy trade, energy conservation and efficiency improvement in the SAARC region. Such institution could be replicable in other parts of Asia wherever needed.

### 3. Opportunities/Benefits

The technical and economic benefits of cross border energy cooperation among neighbour countries are many. It can facilitate and expands a horizon of cooperation and faith, mutual trust. Most importantly by using 'idle'/untapped energy resources and infrastructures partner countries could be benefited significantly by getting option for 'low cost solution' to fulfill their energy demand, or by reducing reserves for peak demand and ultimately improve system efficiency. This type of cooperation is not only ensures better supply security and reliability of energy provisions but also are helpful to building relationship among partner countries. For example, the energy demand pattern of South Asia is a key to leverage Regional Cooperation as important instrument for ensuring energy security. Where Bangladesh has low energy demand in winter, high in dry season for irrigation, while the power demand increases in winter in countries like Nepal and Bhutan for heating purposes. Therefore, exchange of power through integrated regional grid can sustainably manage energy demand at both ends by diversifying primary fuel resources or through export-import provision. Moreover, regional energy cooperation opens chances of foreign investment opportunities to develop or explore untapped primary resources or to construct regional utility grids. Furthermore, it enhances chances to open transit routes for transportation of primary fuel such as natural gas, LNG, liquid fuel etc. or to export-import power. It facilitates inclusion of energy from renewables in power grid systems to reduce/offset dependency on fossil fuel based energy to becoming 'Smart grid'. By means of regional energy cooperation there will be possibility to get support from other partner countries to capacity building of energy utilities to intensify performance of the energy utilities through accomplishments of comprehensive regional schemes. Last but not least, it offers transfer of technology, sharing best practices at regional level.

**3.1 Challenges:** The challenges of regional energy cooperation establishment are many. There is a significant level of political risk in some of the countries in Asia particularly in the context of cross-border energy/power trading which could lead to uncertainties in policy, legal and regulatory regimes. Naturally these uncertainties also transform to commercial cost/ risks in the form of exchange rates, taxes and duties, repatriation of earnings and transaction costs etc. The major challenges so far identified by interest group are;

- Lack of trust
- Dynamic and Uncertain Regional Political Climate
- National policy and Mind set
- Monetary Obstacles/Investment reluctance
- Social Obstacles (Voting power against cross border/regional cooperation )
- Environmental Obstacles (such as Hydropower generation and the construction of multipurpose projects are considered to have significant environmental repercussions)
- Technical and Infrastructural Obstacles (such as Grid synchronization)
- Absence of a Platform for Cross-Border Regulatory Coordination
- Absence of legal and regulatory framework

- Absence of energy trade framework
- Tariff and Non-Tariff Market Barriers (different tariff structure)
- Ownership structure and contractual practices
- Limited knowledge on effective international negotiation mechanism
- Poor operational efficiencies and lack of credit worthiness of Utilities
- Grid Stability (tolerable grid instability/establishment of Smart Grid)

**3.2 Priorities:** To build up regional cooperation among candidate countries by means of cross border energy trade/ development, priority must be given to improving physical connectivity and building institutional linkages between the energy-surplus and energy-deficit countries. To achieve cross border energy cooperation the priorities should include but not limited to the followings;

**Political Alignment:** First of all political commitment and active role from country leaders/government are very much essential to take initiatives and to established cross border energy cooperation. Otherwise, huge investment for cross border energy project will have a chance to be failed and initiative of regional cooperation approaches can lose confidence/motion. Therefore, political support at the national level, however, remains the predominant and crucial factor for regional integration.

**Crisis Management Measures:** It is known to us that the oil price has significant role on various development sectors and business stability, energy security and world economy. Therefore, one approach is to preserve certain discovered reserves of oil/gas as a strategic stockpile to be activated to full production whenever prices for crude oil and gas are too high in international market for the crisis management. In addition, regional countries can create an oil price contingency fund as a means to finance the additional cost burden during short price spike periods.

**Establish a regional electricity grid:** To develop the energy sector in the region rationally, establishment of a regional grid is a prerequisite for cross border energy trade and security. The advantages of such infrastructure as a backbone are many and it can help to stabilize the grid system with quality service, to meet up regional needs of electricity.

**Establish a regional gas grid:** An independent regional gas grid if possible through major pipelines connecting India or Pakistan with Central Asia or the Middle East materialize, the feasibility of expanding the natural gas grid to Pakistan, India, and Bangladesh could be explored as a step towards the development of a regional gas grid. Such gas grid can help to keep the gas price moderate and idles hours of gas based power station/fertilizer industry whenever cannot run due to shortage of gas could be minimized.

**Building regional Institutional linkages:** To achieve cross border energy trade, sub-regional leading to regional energy cooperation is inevitable. And that could get a shape by building institutional linkages among the partner countries. For example, that institution linkage could be Foreign Ministry to Foreign Ministry, power utility to power utility linkage.

**Adoption of PPP Projects:** Regional energy projects/infrastructure is always a huge project/ infrastructure in nature. There only investment from government side is not sufficient for such Programme/infrastructure funding. Therefore, Public-Private partnership initiative is a necessity for maximum cases.



**3.3 Approaches:** The following major approaches but not limited are to be considered to build regional energy cooperation to make cross border energy trade fruitful;

- Policy harmonization of different regional countries
- Harmonization of standards and codes of different regional countries
- Diversifying Source and Origin primary resource sharing
- Set-up regional infrastructure (Sub-Regional/Regional electricity and gas grid, hydro power plant etc.)
- Capacity building through Knowledge and data sharing, best practices sharing, training, knowledge management etc.
- Creation of internally consistent database for use of all member states
- Building a strategic petroleum reserve in the region
- Joint research work from member states to avoid technical shortfalls/difficulties
- Establish solely an Asian Infrastructure Development Financial Institution
- Mutual Fund-raising/ fund creation on bilateral/multi-lateral basis
- Strengthening regional organizations/ government bodies (especially Foreign Ministry)
- Development of regional energy markets
- Joint Investment (for huge projects such as hydro power)
- Short, medium and long term cooperation strategies

#### 4. Remarks/Conclusion

Cross border energy cooperation can utilize idle infrastructure, liquidity, transportation route, knowledge management capacity etc. Sub-regional energy cooperation frameworks can be the building blocks for a regional energy cooperation platform to help link energy-surplus and energy-deficit countries. This would facilitate joint investments by energy buyers and sellers in improving intra-regional energy transport as well as the development, commercialization and dissemination of energy-efficient technologies. Moreover, Cross border energy cooperation can be a supplement for national programs to boost growth and energy security. Therefore, it will be helpful to achieve majorly energy related sustainable development goals of UN.

Establishing a dedicated unit under Ministry of Foreign affairs to deal with energy and climate change and be informed well updated with relevant programs, agreement, treaties is a necessity to facilitate the cooperation.

#### References:

1. ADB, Philippines (2012) 'Energy trade in South Asia: Opportunities and challenges, ISBN 978-92-9092-631-3.
2. 6<sup>th</sup> five year plan (Country Strategy Paper), Bangladesh, 2011, Page 123
3. Anoop Singh (June 2015), 'Cross-Border Electricity Cooperation in South Asia', WB Group, Development Research Group, Environment and Energy Team, Page-7

4. Priyantha and P. N. Fernando (2015), 'cross-border power trading in South Asia: A Techno Economic Rationale', ADB South Asia working paper series-38, Page-10
5. Lahiri-Dutt, Kuntala. "Energy Resources: Will they be the last frontier in South Asia?" Research School of Pacific and Asian Studies, ANU
6. South Asia Regional initiative for Energy Cooperation and Development, "SAARC Energy Center: Strategic and Operational Plans"- USAID Study (August 2006) by Nexant Inc. under contract no. 386-c-00-03-00135-00.
7. Ahmed and Sarkar, 'Energy Cooperation in South Asia: Prospects and Challenges', Page-14, 17
8. Power Point Presentation Slides of Prof. Dr. M. Nurul Islam, BUET, at MNI-IEB Asia Pacific, IEB, Dhaka (2015)

**Web links:**

<http://undocs.org/A/68/970>, <http://www.globalissues.org/article/26/poverty-facts-and-stats>

[https://en.wikipedia.org/wiki/Sustainable\\_Development\\_Goals](https://en.wikipedia.org/wiki/Sustainable_Development_Goals)

<http://www.tradingeconomics.com/south-asia/gdp-per-capita-growth-annual-percent-wb-data.html>

[http://pdf.usaid.gov/pdf\\_docs/Pnads866.pdf](http://pdf.usaid.gov/pdf_docs/Pnads866.pdf)

## **CHAPTER 3. RENEWABLE ENERGY**

## **Solar powered safe drinking water supply schemes for climate vulnerable and salinity affected off-grid coastal people**

M. F. Shadukul Islam Talukder

Deutsche Gesellschaft für Internationale Zusammenarbeit (GIZ) GmbH

[shadukulbd@yahoo.com](mailto:shadukulbd@yahoo.com), [Shadukul.talukder@giz.de](mailto:Shadukul.talukder@giz.de)



Keyword

GIZ, SED, CBO, NGO, CDMP, PSF, BMZ, Desalination, Business Model, Micro Franchise

## 1. Background

During the severe cyclones 'Sidr' and 'Aila' in 2007 and 2009 respectively, large areas of Bangladesh were flooded by accompanying strong tidal surges. Many areas were inundated with sea water of the Bay of Bengal, causing traditional ponds and other surface water bodies to become water logged (with highly saline sea-water) making these unsuitable for any form of human consumption. People, especially women and children, have to collect drinking water from distant sources spending an average of 4-5 hours a day and often walking 2-3 km. People often have no other choice but to drink unsafe water or spend their limited financial resources for transporting or purchasing drinking water. By drinking unsafe pond water people frequently suffer from diarrhea, dysentery, cholera, typhoid, worm infections and other waterborne diseases. On the other hand by drinking saline water they suffer from hypertension, heart diseases, skin diseases, common cold etc. Except for some pockets, all the groundwater aquifers down to 600-700 feet below in 19 coastal districts have become saline due to seawater intrusion. The coastal region is home to about 20 million people and some of them are sometimes compelled to drink such water, especially in the dry season when surface water is not available. Experts say intrusion of seawater is taking place because of climate change and the situation is worsening through heavy lifting of groundwater. It is projected that, under climate change condition in 2050, within the saline zone, area under severe salinity (salinity >2000ppm) will be increased by 14%.



In rural Bangladesh, there is almost no water distribution network, facilitated by the government, but the exception is some shallow and deep tube well. However, these sources can hardly be assumed to be safe due to the presence of arsenic of intolerable limit. The situation is more severe in case of coastal zones due to salinity intrusion.

People in the coastal zones, on the other hand, are not able to install the capital intensive safe water distribution system at their own. While GIZ and other development organizations have taken initiatives to solve the pressing problem, there is still huge gap between demand for and supply of safe water.

## 2. Overview of the Project Intervention and its Development by GIZ

Though there is a huge demand of fresh water in the studied regions, there is not enough supply of fresh water for the locals. Previously, the village people used to collect fresh water from deep tube wells installed around their homes. However, situation has much worsened

in recent years as most of the groundwater aquifers down to 600-700 feet below in the 140 upazilas of 19 coastal districts have become saline due to seawater intrusion.

To tackle this situation, some of the local entrepreneurs, who have the financial capabilities, have installed diesel powered water pump to extract ground water from more than 700 feet below. Locals who don't have the ability to install such pumps, purchase the water in a jar of 10/20 liters from these entrepreneurs

There are also some people who collect drinking water from the uncontaminated surface water sources like river, canals and ponds. Use of tube wells in coastal areas is not common, and most people use either pond water or rainwater during the monsoon season. But in the dry season, it is difficult to find drinkable water. People who live near these sources are quite fortunate, while others have to go to a distant place to collect fresh water – which becomes very difficult especially for the women and the children.

In this backdrop, GIZ Bangladesh under its Sustainable Energy for Development (SED) programme installed deep underground and surface water pumps in off grid areas that are powered by Solar Energy. The intervention of Solar Photovoltaic Pumping (PVP) for drinking water supply started in 2010 to ensure safe drinking water for the cyclone victims, as an emergency relief measure. 12 nos. of the water supply system was installed as a pilot phase. The primary aim was to assess and evaluate the impact of the installed system.

The successful result from the pilot phase directed for further dissemination. Therefore, in 2011, Comprehensive Disaster Management Programme (CDMP) collaborated with SED targeting disaster prone south-western region of Bangladesh. CDMP provided pipelines and dispensers for 60 nos. plants, and GIZ supported the technical construction using fast start finance from BMZ. Based on the water source (Ground and Surface) availability GIZ has constructed Solar Pumping system until 2013, focusing on the target group of cyclone victim areas.

There are noticeable areas in Bangladesh that is already contaminated with saline water. As a part of climate change and shrimp farming, drinkable ground water is contaminating with salinity. Therefore, GIZ is proposing another feasible technique that can remove salinity from the existing saline water and convert it into safe drinking water. As a result, SED, as a part of the dissemination concept has also started installing solar powered drinking water supply with desalination system.

## 2.1. Project area

In collaboration with BMZ, GIZ built 122 units of solar powered drinking water supply systems in between 2010-2015



Figure 3 Project districts

Technology used	Water source	No
PSF	Pond water	85
Underground	Ground water	35
Desalination	Canal/Ground water	2

Figure 2 Technology wise number of projects

District	Number of sites
Satkhira	25
Bagerhat	48
Borguna	10
Pirojpur	3
Khulna	35
Gopalganj	1

Figure 4 District wise number of projects

### 3. Technology

Water is pumped by using solar energy to overhead tank, sent by gravitational force through underground pipeline (2-6km) near to household clusters (8-10 dispenser points). For surface water sources, a simple pond sand filter is used for micro bacterial contamination removal.

#### 3.1. Non saline water sources

Two types of solar powered water pumps have been installed in off-grid areas, considering the water source availability:

- 1) Ground Water Plant
- 2) Pond Sand Filter (PSF) Plant.

Ground Water Plant is installed in the areas where underground (non-saline) water source is available. Therefore, separate filtration system is not implemented in the system, as the underground water comes from deep aquifers. For surface water treatment, Pond Sand Filter (PSF) is a conventional and popular system for the filtration of pond water in coastal belt areas. It is a widely accepted low-cost technology with very high efficiency in turbidity and bacterial removal.

Each water supply system has three main components e.g. (1) Water filtration system (for pond/surface water) (2) Solar pumping system (3) Water distribution system.

For Ground Water Plant, as mentioned before, a filtration system is not required as the water is by nature safe and suitable for drinking. The water from deep aquifers is drawn with a submersible pump that is run by solar panels. The submersible pump is placed deep into the ground below 80-100 feet, and pumps water to an overhead tank placed 22feet above from

the ground level. The overhead water tanks are hurricane-proof with concrete platform from where a number of pipes lead to various water distribution points in the villages. The solar panel is angled 19 degrees facing to the south to get the optimum efficiency.

The PSF plant draws water from the source following the similar technique of Ground Water plant, consisting overhead tank, motor and panels. It is generally constructed near ponds that should not be used for washing and bathing purposes. Through this plant the saline surface water is cleaned into drinkable non-saline water implementing filtration mechanism.

PSF system comprises of three horizontal successive set of chambers.

One typical filter chamber contains a layered graded sand bed and graded brick chips through which the water trickles. Water from the pond is pumped into the first chamber from which it seeps into the filter bed in the next chamber.

Potassium Aluminium Sulphate (locally available and known as 'Fitkari') solution is mixed with water in the second chamber. Fitkari has antiseptic and antibiotic properties. It can also clump negatively charged particles to form flocks that settle at the bottom; therefore water can be filtered easily.

An activated carbon bed is added to the last filter chamber. Activated carbon filtration can effectively reduce certain organic and chlorine compounds. It can also reduce the quantity of lead, dissolved radon and taste- and odor causing compounds. The accumulated filtered water is lifted, using motor pump, to an overhead tank.

3 inch Delivery pipe (uPVC pipe or GI pipe) is fitted with the overhead tank to collect water from the source and to supply to the ground, for both plants. Gravity flow based water distribution system is maintained by using Food grade High Density Polyethylene (HDPE) pipes. Pipe lines are placed underground usually by the roadside to provide water to 'standpipe' dispensers/taps near community dwellings. 2 inch, 1.5 inch and 0.5 inch HDPE pipes are fitted based on the length of the pipe lines; generally the lengths are 1.5 km, 1km and 0.5 km respectively.



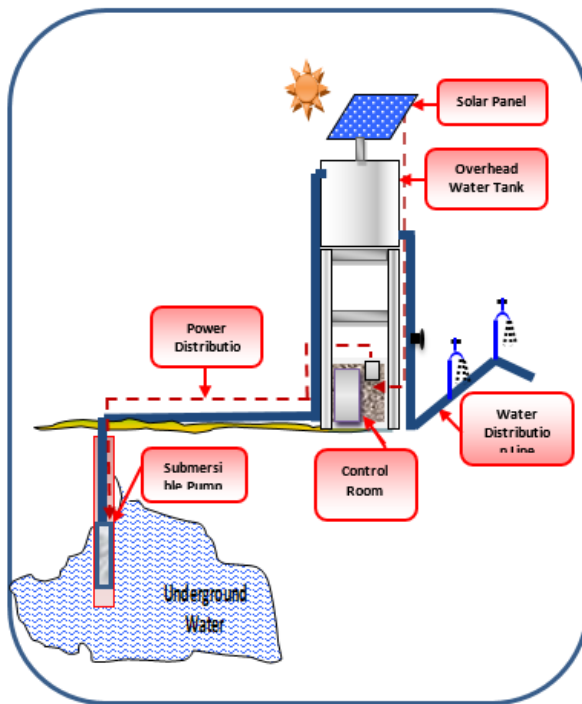

**Figure 5: Diagram of Underground water plant**

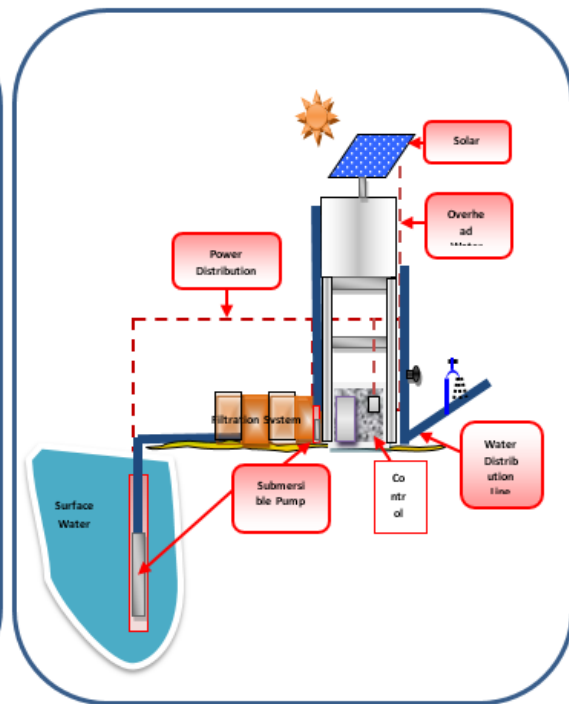

**Figure 6: Diagram of Pond Sand Filtration**

### 3.2. Saline water sources

Another feasible technique has been installed to remove salinity from non-drinkable saline water source. The solar powered water pump is equipped with desalination filter system. It converts the

The saline water is filtered in 2 mechanism 1) Pre-treatment section 3) Reverse Osmosis (RO) section

The saline water is pumped to the pre-treatment section which consists of Multimedia Filter and Activated Carbon Filter. The multimedia filter reduces the level of turbidity of water by decreasing the flow rate into trickle pace. Then the water is flowed into the activated carbon filter to reduce certain chlorine and organic compounds.

Before entering to the reverse osmosis mechanism section, the dosing pumps add acid and anti-scalant chemical substances to the filtered water from pre-treatment section, to improve the water quality and efficiency of the RO membranes.

In the RO mechanism, the soluble materials and compounds are filtered to remove salinity. The RO membranes are a semi-permeable membrane through which the saline water is passed. It is done by applying external high pressure through a pump. After this process, saline free potable water is collected in the water tank. A post treatment unit is used to

disinfect and destroy bacteria and viruses before water distribution. It is done by applying Ultra Violet (UV) ray in the non-saline water.

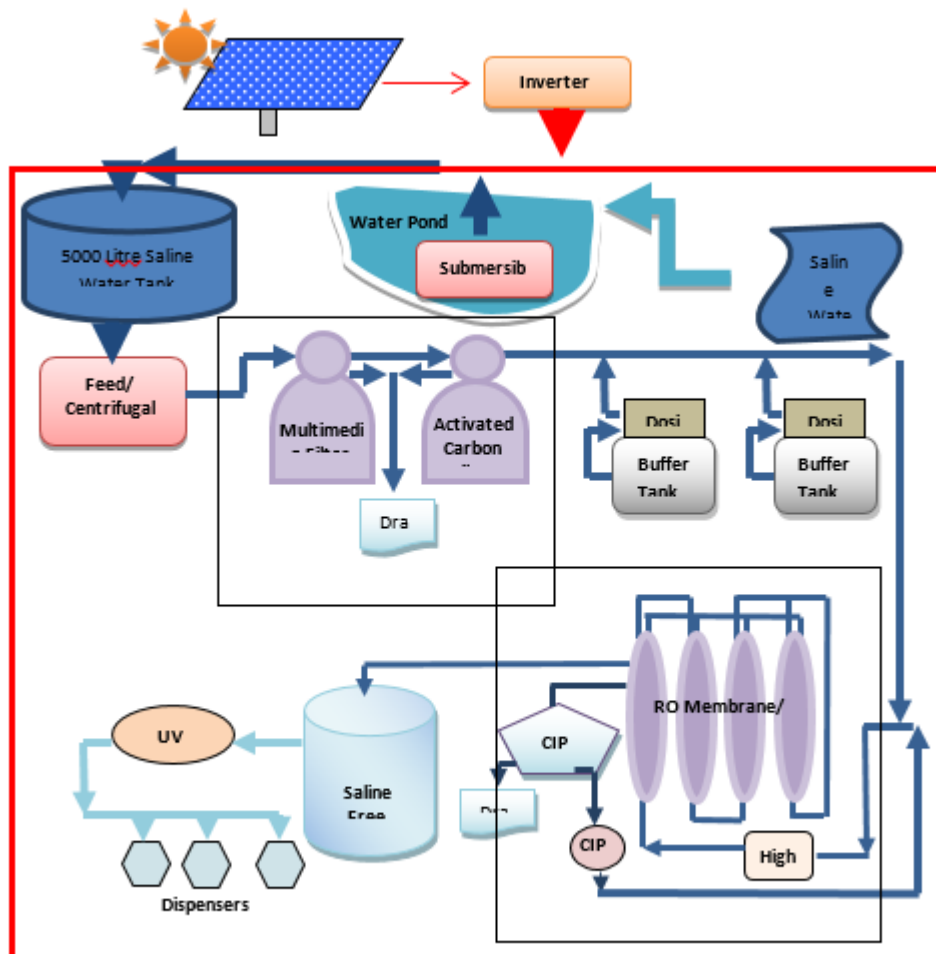

Figure 7 Desalination Plant

#### 4. The Existing Business Model

All the systems have been handed over to the community for operation. In most of the intervention areas, the community based organization (CBO) is managing the plant. This business model is completely subsidized for capital expenditure. The existing model is capable of recovering the operational expenditure and running costs. 50% of the operational models generates sufficient revenues for operation, maintenance and repair and are operating in sustainable manner. The rest 50% of the systems still require a business model that is self-sustainable, scalable and financially viable and affordable for the marginal poor inhabitants residing in these coastal areas. Since the upfront capital investment for the infrastructure cannot be recovered from the revenue to be generated from selling water due

to the nature of the project and the income level of the target groups GIZ planned to recover the operation and maintenance expenses from the generated revenue.

This business model is completely subsidized – GIZ still holds the ownership of these pumps and bears the operational expenditures, mostly repair and maintenance activities, in most areas. However, there are a few areas where the communities collect monthly subscription fees to bear the operational costs.

## 5. Sustainable Business Models

With this end in view, currently the following three different business models are being piloted in 9 selected areas.

### 5.1. Micro Franchise/Entrepreneurship Model

Since the facilities will be handed over to the government at the end of the project and the local government doesn't have the human resources to operate and maintain them, this model will engage private entrepreneurs as an intermediary between the government and the beneficiaries. This model is feasible for GIZ solar powered water pumps since there are some private entrepreneurs who are already doing this. The model can easily attract the local large scale entrepreneurs since there is no CAPEX to be incurred in the initial phase. The simplicity of the model allows the private entrepreneurs to engage easily with minimum level of hassle (if any) and bureaucracy from the government.

The first variation of the current model would be a micro-franchising model, where the respective government entities would own the assets and the technology but will outsource the operations to a private entrepreneur or enterprise in the project areas. The franchisees would in turn charge users of the taps on a monthly basis, having the incentive to collect the payments on time, with oversight from government representatives.

The government would then monitor the operations and ensure fees are being collected properly and that maintenance of the different pumps is being carried out properly. For this purpose, an accounts and admin entry has been included in the model. This person will be the bridge between the government and the organization operating the pumps at the field level.

The monitoring mechanism would help mitigate the non-payment issue and at the same time ensure that funds are being used to conduct the proper maintenance. This model would make huge profits, as the operation would cover the entire district, which means opportunity to reach economies of scale and leverage multiple resources to minimize cost and optimize operational expenses. Another positive about this business model as mentioned earlier is the payment collection process, which should be more efficient as it will be run by entrepreneurs who have more incentive to it than the community members.

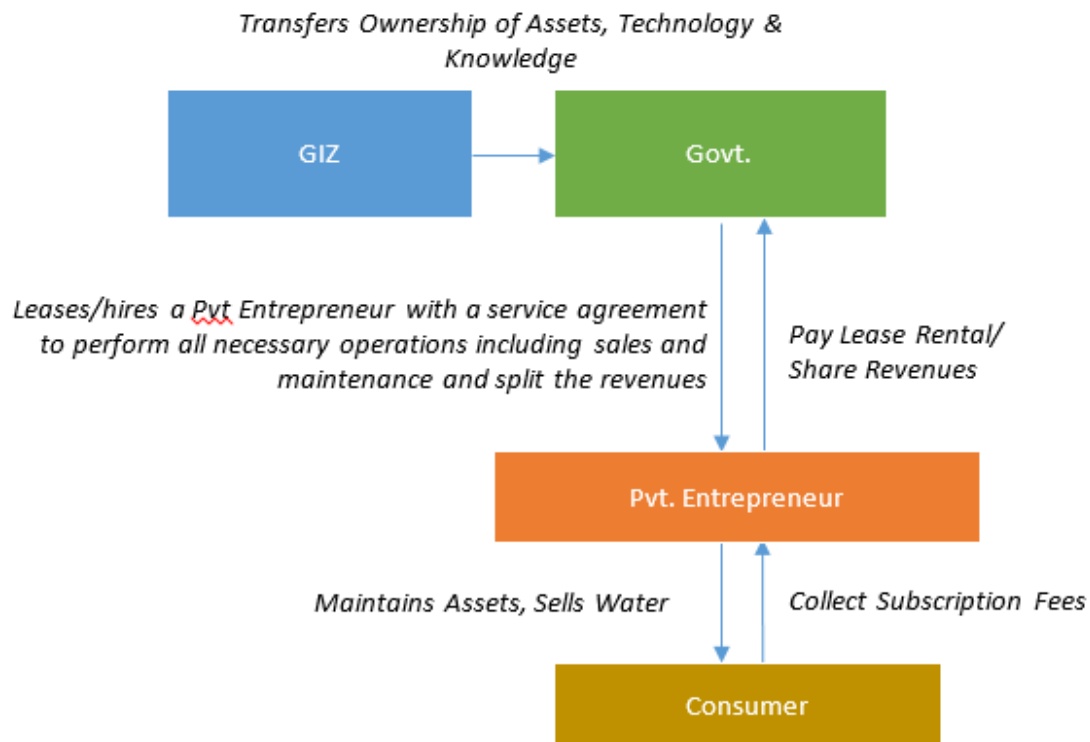

**Figure 8 Micro Franchise/Entrepreneurship model**

## 5.2. NGO Model

NGO model is a feasible one since the NGOs already have their MF functions operational. They have the existing staff to collect the monthly subscription fees and they are quite efficient in building relationships with the beneficiaries and collecting fees from them.

The NGO model shares similar characteristics of the micro-franchise model due to large scale of operation and reaching the economies of scale with their vast network and resource cross-subsidization. Mainly, in this model an NGO will replace the Pvt Enterprise from the previous model as the execution partner to the government. The government will be the owner of the assets and the technology, while the NGO will be responsible for the maintenance and fees collection of the pumps as well as all service related issues.

Similar to the micro-franchising model, the revenue sharing with the local government entities will be 95% NGO and the rest will be local government. Important thing is the initial CAPEX for the entire business is either zero or minimal as it has already been taken care off

by the GIZ Bangladesh and they only have to cover the future expenses, which makes the business more lucrative for the NGOs

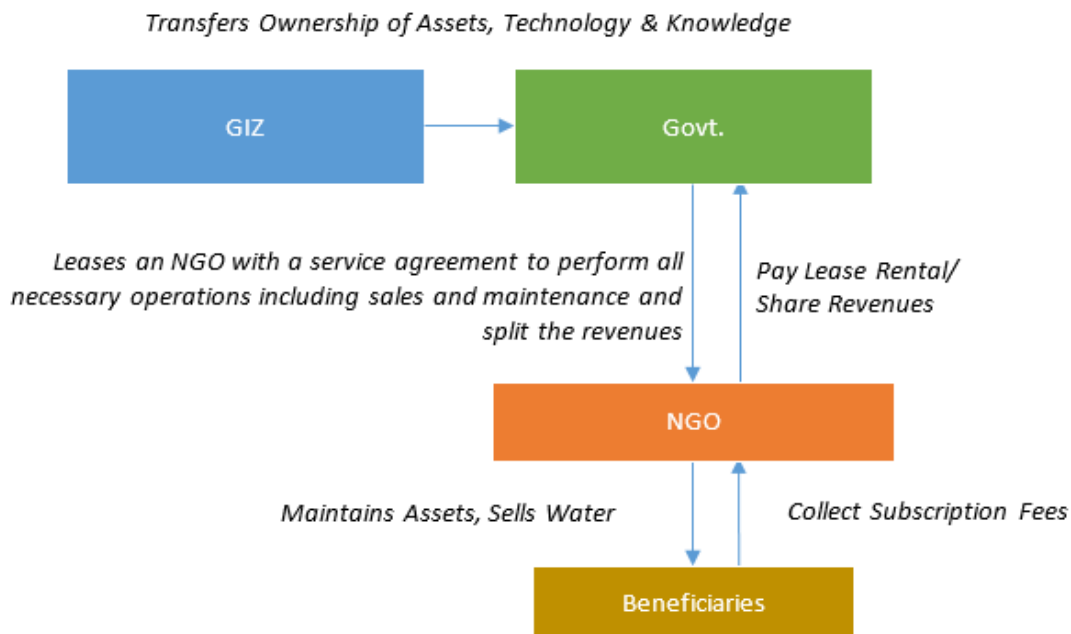

**Figure 9 NGO Model**

### I. 5.3. Community Based Organization (CBO) Model

CBO model states that the assets, technology and the knowledge will remain with the govt. while the local govt. will form a management committee and appoint a caretaker to operate and maintain the pumps.

In terms of sourcing of drinkable water in the regions under investigation, the team found that the model being used was closest to a community based one where the solar water pumps are being operated under the supervision of the Union Parishad chairman or land owners with the help of a local community. In this model, the revenue earned as well as the costs related to the maintenance and upkeep of the solar water pumps is being borne by the community.

This model has a major limitation in that the incentive structure for the maintenance of the setup is weak. This leads to some areas with dedicated UP chairmen getting strong services from the pumps and accompanying taps, while others are left in an inoperable state, causing suffering for the rightful beneficiaries and damaging the outcome of the project.

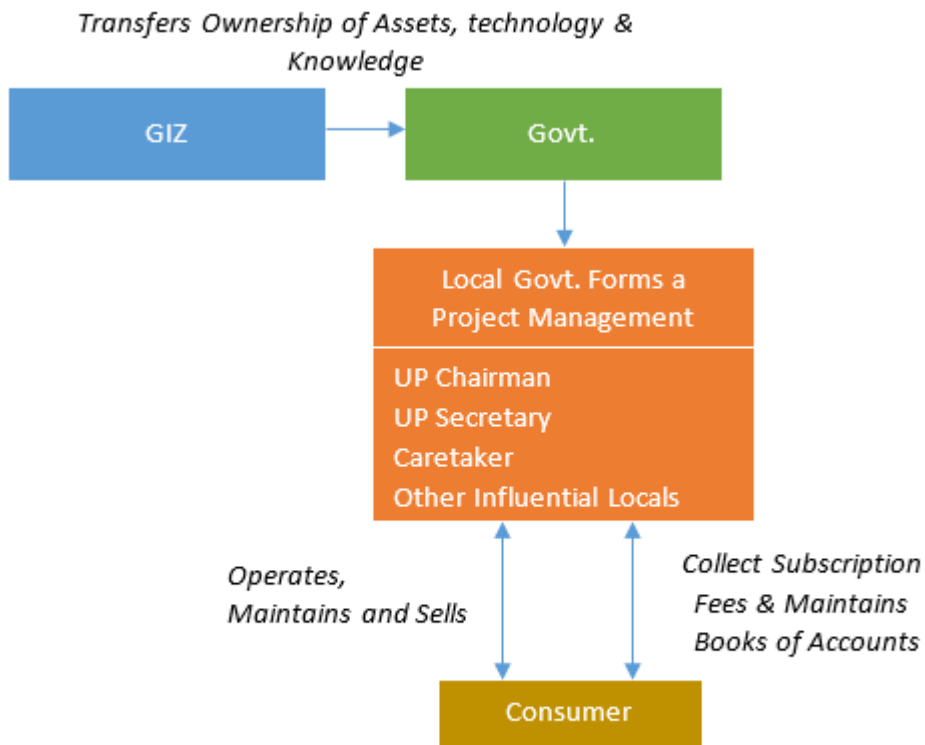

**Figure 10 CBO Model**

## 6. Conclusion

Currently these three different business models are being piloted in 9 selected areas. At the end of the business incubation period, all the systems will be transferred to the Government counterpart, where the recommendation will be to transform all of the sites into the viable business case.

## **Solar Power Based Mgiri Technologies for Agriculture and Agroprocessing Industries And Its Impacts**

**Mr. Kandasamy Ravikumar**

**Deputy Director**

Mahatma Gandhi Institute for Rural Industrialisation (MGIRI), Maganwadi, Wardha-442001, Maharashtra, India.

Tel: 0091-9423885810, Fax: 0091- 7152- 240328, Email: [karavikumar@gmail.com](mailto:karavikumar@gmail.com)  
(or) [karavikumar@yahoo.com](mailto:karavikumar@yahoo.com)

### **Keywords**

Solar Energy – application in agriculture and agro processing industries - machine development - entrepreneurship creation (SME development) – development of rural industrialisation – innovation (products and processes)

### **Background of the issue**

Rural industrialization is the major focus of many developing nations since majority of the people (farmers) are involved in it and they are at high risk due to impacts in climate change etc. To develop them a suitable solution is to be developed in a sustainable way.

### **Objectives**

To help this sector in new ways of increasing the productivity, value addition to their products or processes and to create entrepreneurs through MGIRI technologies.

### **Methods**

**Mahatma Gandhi Institute for Rural industrialization (MGIRI):** Gandhiji started the All India Village Industries Association (AIVIA) on 14-12-1934 in Wardha. AIVIA had a Board of 18 advisors consisting of distinguished scientists like Dr C V Raman and Dr J C Bose and also many leaders in public life and industry: Rabindranath Tagore, G D Birla, M A Ansari, and Satish Chandra Das Gupta among others. The AIVIA got reorganized in Maganwadi, Wardha, Maharashtra, India in a spacious orchard belonging to Seth Jamanalal Bajaj. Gandhiji stayed here with Kasturba during 1934-36 and supervised the works of AIVIA which became a hub of rural industrial activity and a centre to coordinate industrial experiences and knowledge from all parts of the country with focus on research, production, training, extension, organization, propaganda and publication. After demise of Gandhiji, Dr Kumarappa became its President and Dr G Ramachandran his Secretary from 1949 up to 1951. The Khadi and Village Industries Board (KVIB) created the Jamanalal Bajaj Central Research Institute (JBCRI) in 1955 to carry forward the R&D works of AIVIA, From 1st April

1957, the Institute came under the KVIC which itself was established in 1956. The objective of JBCRI was to carry on research and investigations into the problems of village industries and in particular the development of improved tools and techniques. When KVIC adopted a more inclusive definition of rural industries which permitted infinite number of activities vide M. Ramakrishnayya Review Committee Report 1987, a new pattern of R&D support system became necessary. Thus revamping of JBCRI into Mahatma Gandhi Institute for Rural Industrialization (MGIRI) based on a 'hub and spokes model' was initiated in 2001 to meet the technological challenges arising out of the above paradigm shift.

Mahatma Gandhi Institute for Rural industrialization (MGIRI) at Wardha was developed during 2001-2008 by the collaborative efforts of KVIC and IIT Delhi. MGIRI was setup as a National Institute under the Ministry of MSME at the historical premises of Maganwadi, Wardha by revamping JBCRI. Its autonomous function started effectively from October 2008. Vision of MGIRI: To Support, Upgrade and accelerate the process of Rural Industrialization in the country so that we may move towards the Gandhian vision of Sustainable village economy self sufficient in employment and amenities and to provide S&T inputs to make the rural products and services globally competitive.

The main objectives of the institute as enunciated in its Memorandum of Association include:

- To upgrade and accelerate the process of rural industrialization for sustainable village economy so that KVI sector co-exists with the main stream
- Attract professionals and experts to facilitate rural industries become globally competitive
- Empower traditional artisans
- Promote innovation and foster creativity in products and processes through pilot study/field trials
- R&D on alternative technology using local resources for sustainable rural development

The strategy adopted by MGIRI to realize the above objectives, includes setting up linkages with other reputed institutes of excellence, sponsoring projects in mission mode, providing services to rural entrepreneurs, piloting projects and transferring technologies, conducting specialized HRD programmes, resource survey, etc

**Roadmap for MGIRI:** Set up a strong two-way linkage between itself and the rural industrialists and technical experts in professional Institutes so as to facilitate quick availability of modern science, technology and management inputs for rural industrialization.

- Create a science and technology hub for KVI sector by developing strong linkages and interface with other Institutions in the field of rural industrialization.
- Build a database of technologies available in KVI sector.
- Facilitate setting up of rural industrial estates and clusters with necessary infrastructural facilities like power, specialized tool rooms, testing and marketing facilities.
- Undertake and sponsor projects capable of giving substantial fillip to larger and increased market penetration to selected products of village industry.
- Promote innovation through pilot studies and field trials through research, extension, education and training.



- Conduct specialized human resource development programmes in generic areas such as Total Quality Management, creativity and innovation besides, rural entrepreneurship development.
- Provide Training to Trainers of the Centres of KVIC and Khadi & Village Industries Boards of state governments.

### Functioning of the Hub

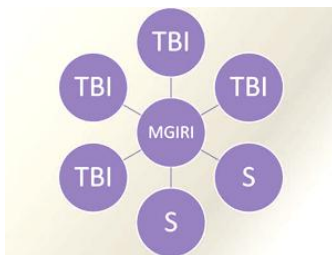

MGIRI, Wardha consists of six major divisions catering to the generic areas of rural industrialization as given below:

- Khadi & Textile Industries division
- Bio-processing and Herbal based Industries division
- Chemical Industries division
- Rural Crafts and Engineering division
- Rural Infrastructure and Energy division
- Management and Systems division

The necessary infrastructural facilities to cater to current requirements of the above sections have been developed. However, the approach to be followed by MGIRI will be primarily to act as a facilitator and as nodal networking institute for promoting Rural Industrialization. Accordingly, only selective R&D work will be carried out at the MGIRI campus and all efforts will be made to direct the projects to respective interfacial working groups and expert organizations after appropriate need identification as well as competence matching. Presently, there are 14 interfaces and it is planned to setup another 20 to 25 interfaces during the next 5 years to create a wide network throughout the country.

MGIRI is trying to achieve it through S&T Intervention in the processes, Innovation in product development and entrepreneurship development.

### Results

The innovative green initiatives available in the agro-industries through renewable energy mainly through solar energy. Agro-Industries may differ from the large Industries in scale or in different aspects but energy, is the prime necessity which is not fully available in rural sector and for SME's.

Rural industries (specifically Micro & Small industries) have the advantage of being small and also get the energy needs through renewable energies or energy conservation through locally available resources, redesign of the existing systems, and innovations. Solar Applications in cotton to garment processing is highly effective since it is possible to promote the decentralized solar applications through segmenting the textile process machineries The

use of solar energy in various applications commonly used, Solar Cotton to Garment Business Unit, Solar Charkhas implemented all over India in Khadi Sector, Mini Solar Spinning Unit and Solar Powered Power-looms in Tirupur & Auroville in Tamil Nadu. The new DC Drive system coupled to the same power loom consumes about 300 Watts of Power thereby resulting in power savings of more than 50%. The locally available renewable energy resources helps in providing sustainable employment throughout the year.

### **Solar Cotton to Garment Business Unit**



### **Mini Solar Spinning Unit**



### **Solar Powered Power-looms in Tirupur & Auroville, T.N**



The use of Solar powered machines used for Agricultural processing and artisans are shown below:

### **Poultres & Hatcheries**



**150 Yellow CFL (16 W)**

**Replaced with Yellow LED's (4 W)**

The use of solar powered machines is possible for Water pumping and agricultural processing. viz Solar pump, Solar fodder machine, solar fruit grader, etc.

### **Agriculture & Processing Machineries**

#### **Solar Pumping system**



#### **Solar Fodder Machine**



#### **Solar Fruit Grader**



**Other Micro & Small Enterprise Applications identified & conditioned for Green Energy**

**Dhoop-batti machine**



**Liquid Filler**



**Auger Filler**



**Spices packing & sealing machine**



**Gomutra (Cow urine) processing  
Solar still**

**Solar Evaporative cooler**



**Food Industries**

**Solar Micro Dal Mill**



**Solar Food Drier**



**Vegetable Cutting Machine**



**Ground nut decorticating machine**



**Tur trashing machine**

**Cereals decorticating machine**



Renewable energy concept in villages focusing on the micro level applications through solar power which would serve for energy efficiency and saving power and facing the challenges ahead in the energy sector are demonstrated through exhibitions



# Powering Agriculture Waste for Sustainable Power Generation in Indonesia

## Powering Agriculture Waste for Sustainable Power Generation in Indonesia

Vegaswarasti Kumala

Deutsche Gesellschaft fuer Internationale Zusammenarbeit (GIZ) GmbH

[vegaswarasti.kumala@giz.de](mailto:vegaswarasti.kumala@giz.de)

### *Keyword*

*bioenergy, climate change, energy resilience, green economic, renewable energy*

## 1. Background of the issue

Indonesia has abundant renewable energy source as the country is blessed with its vast and fertile soils. These valuable resources are what make the country a major global key producer of a wide variety of agricultural tropical products. As the largest archipelago country followed by rapid population growth, Indonesia is still facing deficiency electricity supply in the rural areas. Additionally, electricity generation is still dominated by fossil fuels, which leads to high greenhouse emission. Moreover, fossil-based energy is depleting, and it is imperative that Indonesia shall explore renewable source of energy that is not only clean but also sustainable. The major agriculture industries in Indonesia have been identified into three commodities, such as palm oil, rice paddy, and sugar cane. Those major agriculture waste commodities have an equivalent power capacity of 46 GWe (Prasetyaning & Conrad, 2014).

In 2015, the total production of rice paddy industry in Indonesia was about 71 mio tons. By utilising the main by-products of rice milling, rice husk, could lead to potential installed electricity capacity of about 1,500 MW depends on the conversion technologies used. Rice husk is produced approximately 20% of rice paddy production by weight. Thus, the energetic use of rice husk has a potential role to replace diesel as now is the main power source in rice milling industries in Indonesia.

Issues surrounding global energy supply and demand, such as the limited reserve of fossil fuels, biomass feedstock security, limited access to energy, technology gap, barrier to clean energy investment, and climate change, must be addressed and long term solution must be sought.

### 1.1. The profile of rice industries

According to the rice mills census conducted by Badan Pusat Statistik (BPS)<sup>41</sup> in 2012, the number of rice mills in Indonesia reached 181,199 units consisting of:

---

<sup>4</sup> Badan Pusat Statistik (BPS): Indonesian Central Bureau of Statistics

a. Small Scale Rice Mills

Small scale rice mills have production capacity of < 1.5 ton per hour. It has 171,495 units.

b. Medium Scale Rice Mills

Medium scale rice mills have production capacity between 1.5 ton – 3 ton per hour. It has 8,628 units.

c. Large Scale Rice Mills

Large scale rice mills have production capacity of > 3 ton per hour. It has 2,076 units.

The percentages of rice mills in Indonesia is depicted in figure below:

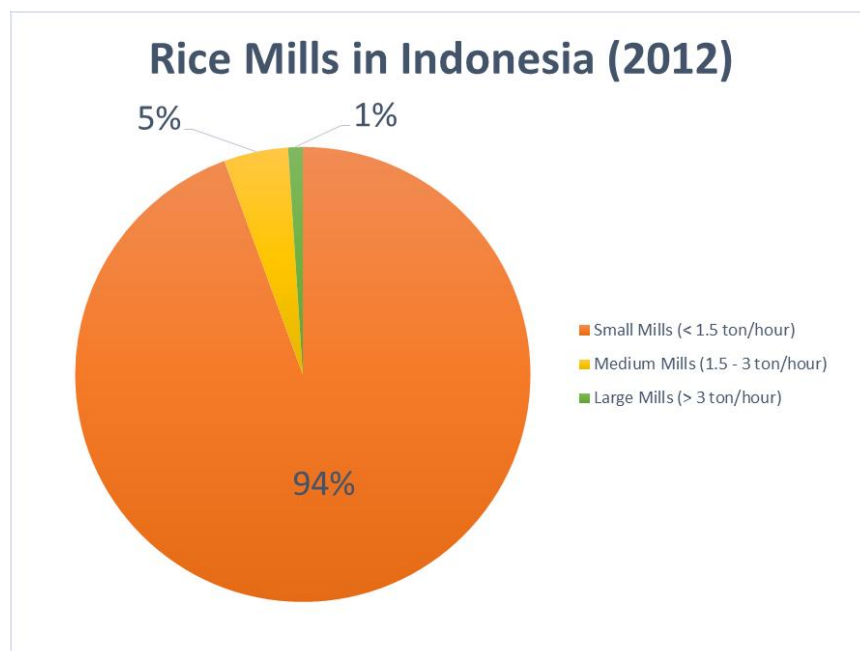

Figure 1.1. The Distribution of Rice Mills in Indonesia (Badan Pusat Statistik, 2012)

Due to high electricity price for industry, most of rice milling industries in Indonesia use diesel generator as electricity sources. The primary data on diesel consumption is elaborated in the chapter 3.

## 1.2. Key issue on the rice milling industries

Beside the rice milling capacity, all rice mills in Indonesia are also distinguished by static rice mills (162,976 units) and mobile rice mills (19,223 units). Because the majority of rice industries in Indonesia are dominated by small scale rice mills and mobile rice mills, small



scale rice mills is not able to produce good rice quality and also its by-products, rice husk. Moreover, the paddy production has been decreasing in these years than the demand of paddy in the rice milling industries. Therefore, there are approximately 40% of rice milling industries has been facing difficulties on finding the raw materials. Considering the situation, small scale rice milling industries are only able to mill the paddy for about 3 – 4 months per annum, which burdening their fixed cost as consequence of 8 – 9 months per annum without any rice milling activities (BB Padi, 2015).

### **1.3. The current application of rice milling-by-products**

The main rice milling-by-products is rice husk. The majority of rice husk utilisations are (PERPADI, 2013):

a. Cement industries

PT. Semen Gresik is currently utilising rice husk as their fuel for cement production. The company absorbs approximately 50% of the rice husk production in the area of Tuban and Lamongan, East Java

b. Brick and tile industries

The rice husk utilisation on brick and tile industries is ranging between 15% - 30%, depending on the location.

c. Cattle flooring

The rice husk utilisation on cattle flooring is ranging about 5%.

d. Fertiliser and growing media

Rice husk can also be utilised as growing media in aquaponic system. The utilisation is ranging between 1 – 2%.

## **2. Objective**

Investigating 3 (three) aspects to integrate development strategies for agriculture industry, particularly on rice milling industry towards sustainable energy production in Indonesia. The identification focusses on several aspects, such as: theoretical-, technical-, and economical aspects.

## **3. Method**

The profile data of rice milling industries in Medan, North Sumatera – Indonesia<sup>5</sup> is used to estimate power generation through the utilisation of rice husk for biomass cogeneration

concept. The cogeneration combines the heat and electricity generation for its captive use as diesel replacement. The heat produced can be utilised for drying the paddy, whereas the electricity produced can be used as main electricity source for rice milling process. The excess electricity could provide electricity access for rural areas surrounding the rice milling industries.

### 3.1. Theoretical Potential Aspect

The theoretical potential aspect quantifies the potential electricity generation based on 3 (three) biomass conversion technologies. The basic parameters are elaborated in Table 3.1. below.

### 3.2. Technical Aspect

Technical aspects elaborated 3 (three) biomass conversion technologies, namely steam combustion, organic rankine cycle, and biomass gasification.

### 3.3. Economical Aspect

The economical aspect from different technologies are quantified based on the investment, operation and maintenance cost, in order to estimate electricity generation cost per technologies.

The methodology is elaborated in the figure below:

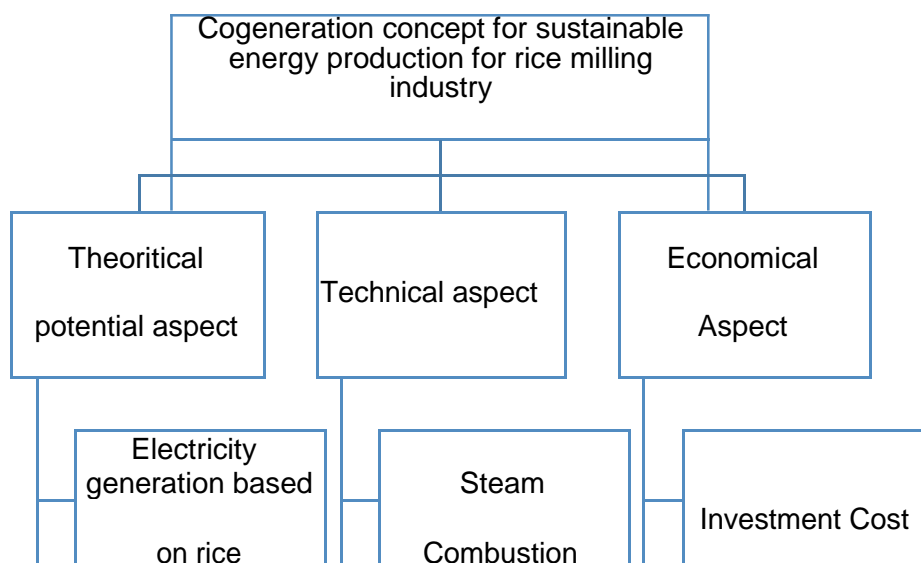

<sup>5</sup> Large Scales Rice Mills > 3 ton/hour

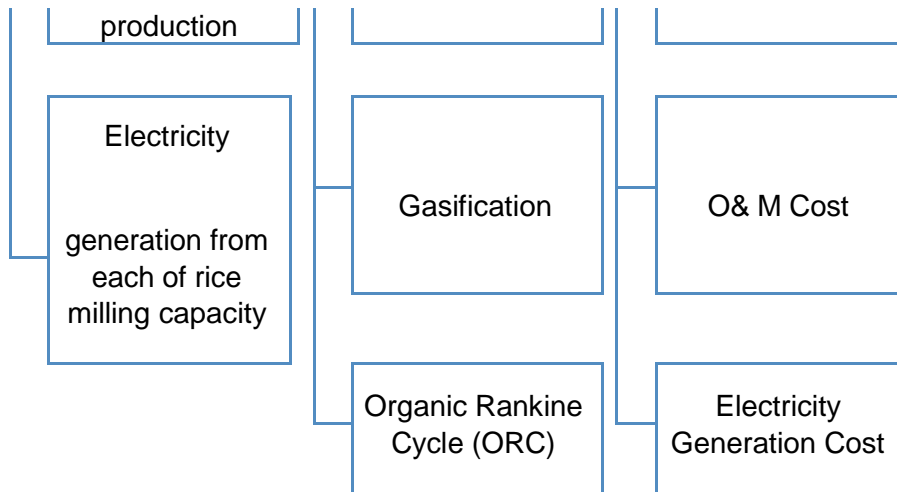

Figure 3.1. Research Methodology on Agrowaste-to-Energy

The primary data to support the identification of 4 (four) aspects for powering agriculture waste-to-energy is elaborated below:

**Table 3.1. Basic Parameters**

Basic Parameters	Unit	Small Scale	Medium Scale	Large Scale
<b>Rice Milling</b>	—			
Production capacity	Ton per hour	1	3	5
Annual working hours	Days per annum	75	150	300
Daily working hours	Hours per day	5	7	10
Diesel consumption	Liter per day	20	150	400
Diesel price	EUR/liter	EUR 0.6/liter or IDR 9,000/liter		
<b>Biomass conversion technologies</b>				
Steam Combustion	Kg per kWh		3.3	
Organic Rankine Cycle (ORC)	Kg per kWh		2.5	

Biomass Gasification	Kg per kWh	2
Annual operating hours	Hours per annum	6,000

Note: 1 kWh = 3 liters of diesel

## 4. Results

### 4.1 Theoretical potential aspect

The rice mills in Indonesia have potential installed electricity capacity of about 2,000 MW. For large scale rice mills, it has a potential installed electricity capacity of about 450 MW. By utilising its agro-waste, the potential electricity generation is able to provide electricity for rice milling process. Thus, it leads to diesel saving up to 120,000 liters per annum, which means potential fuel cost saving of € 72,000 per annum.

### 4.2 Technical aspect

According to different biomass conversion technologies, such as steam combustion, organic rankine cycle (ORC), and biomass gasification, the potential installed electricity capacity is ranging from 3 kW – 200 kW.

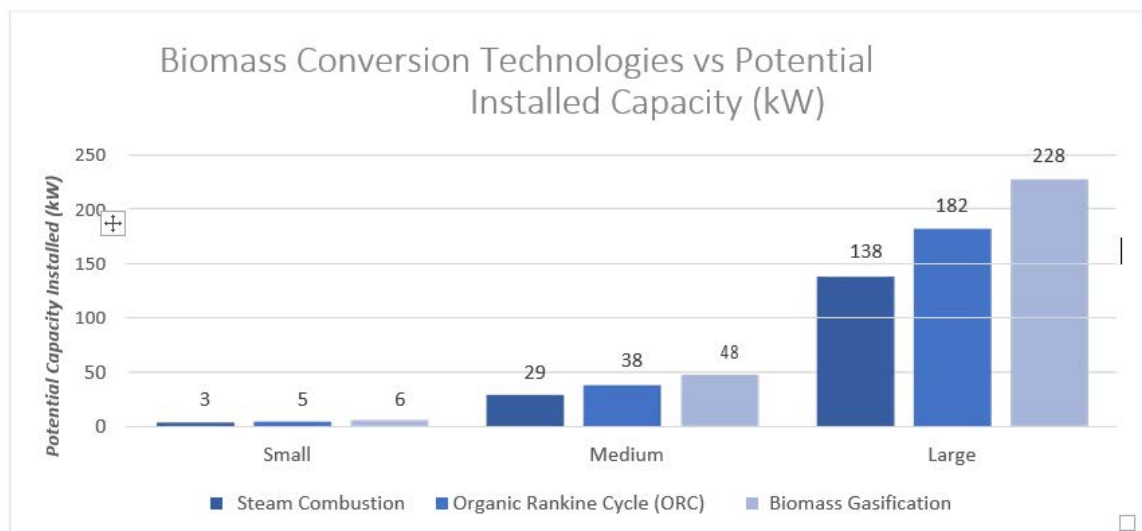

### 4.3 Economical aspect

Based on basic parameters on each biomass conversion technologies, it was calculated that steam combustion has the lowest electricity generation cost, followed by biomass gasification, and organic rankine cycle (ORC). Steam combustion is known as a robust technology to convert rice husk to electricity considering the rice husk combustion behaviour and properties. Aside from generating electricity, rice husk combustion also produces

valuable by-products, as silica. Rice husk has the potential to generate 16.5 – 22 mio. tonnes of ash containing over 90% amorphous silica that could be used to substitute for silica fume (TORFTECH, 2015). The price of silica fume worth about US 1,000/tonne in some markets.

**Table 4.1. Economic analysis of different biomass conversion technologies** (Kwintkiewicz, 2013)

Basic Parameters	Unit	Steam Combustion	Organic Rankine Cycle	Biomass Gasification
Installed Capacity	kW		200	
Usage Period	years		10	
Annual Operating Hours	Hours per annum		6,000	
Investment Cost	EUR/kW	2,100	10,000	3,800
O&M Cost	EUR/kW	550	1,600	520
Electricity Generation Cost	EUR/kWh	0.05	0.2	0.08
	IDR/kWh	750	3,000	1,200

## References

- Badan Pusat Statistik. (2012). *Persebaran Penggilingan Padi di Indonesia*.
- BB Padi. (2015, September 3). Retrieved from Kementerian Pertanian: <http://bbpadi.litbang.pertanian.go.id/index.php/berita/info-aktual/content/171-modernisasi-penggilingan-padi-menyongsong-mea>
- Kwintkiewicz, C. (2013). *Rice Husk to Electricity on Deli Serdang*. Jakarta: GIZ GmbH.
- PERPADI. (2013). *Mapping the potential of rice husk utilisation into energy in Indonesia*. Jakarta, Indonesia: GIZ GmbH.
- Prasetyaning, I., & Conrad, L. (2014). *Overview of waste-to-energy potential in Indonesia*. Jakarta: GIZ GmbH.
- TORFTECH. (2015). Retrieved from <http://www.torftech.com/pdf/Application%20Description%20-%20Rice%20Hulls.pdf>

## **Biogas Development in Nepal: Experiences from the Private Sectors**

Madan Thapaliya  
Nepal Biogas Promotion Association (NBPA)  
mthapaliya2000@hotmail.com

### **Abstract**

Around 87% of the total energy consumed in Nepal is met by traditional energy sources such as fuel wood and agricultural residues. The remaining 13% comes through commercial energy sources such as imported petroleum fuels and hydropower. Cost of fossil fuel is increasing rapidly whereas its availability is decreasing day by day. In this scenario, biogas technology should be our first and foremost choice. Nepal being an agricultural country has a very old tradition of cattle farming with tremendous opportunities to install household biogas plants of more than 1.2 million potential capacities. It has dual benefit like generation of gas and digested slurry, which can be utilized as farm yard manure. Use of slurry as a fertilizer can reduce the demand of imported costly chemical fertilizer. Initially, only cattle dung fed biogas plants were in operation. Now, latrine-attached plants have come up and the number is increasing rapidly. Increasing trend in installation of biogas plants by the private sectors among rural farmers indicates that biogas technology is suitable and affordable to Nepalese farmers.

Experiences from the private sectors were involving in the biogas sector and responding to a real demand of the biogas companies (bottom-up approach). Practice of small sized household dung operated biogas plant has reached a considerable height. Till now, around 350,000 household biogas plants have been installed from the biogas companies under Nepal Biogas Promotion Association (NBPA) and contributed to Nepal's presently facing an energy crisis of unprecedented proportions. Yet, much more of the remote population need to be covered. NBPA which is an umbrella organization for all biogas companies, ranging from 114 to 140 provide construction and after sale services. The government policy to promote this technology through provision of subsidy has made the private sector attractive and has contributed to extension of technological interventions to different parts of the country.

At present, 196,546 biogas plants have been registered in CDM projects for income revenue and reducing emission of 3 ton CO<sub>2</sub>/per biogas plant/per year which is now accepting as important element for environmental benefit. Around 3.3 ton fire wood saving per biogas plant per year helped in reducing deforestation and protect environment and minimizes the use of traditional energy sources such as firewood and agricultural residues and helps in reducing the consumption of LPG gas to a great extent. Therefore, this paper summarise the contribution of the private sectors work as a bridge among Government of Nepal, external

development partners, related stakeholders and grass root level people in the development of biogas sector in Nepal.

**Key Words:** Renewable Energy, Biogas Technology, Policy, CDM Projects and Deforestation

### **Problem Statement**

The main sources of energy that have been used to meet the energy demands are through conventional (87%), commercial (10%) and renewable energy sources (3%) (WECS 2010). In urban areas imported fossil fuel such as kerosene, LPG gas and electricity are used for cooking purposes. Non existence of road access incurs very high cost to transport them to rural areas; as a result these sources are beyond the reach of rural people. Generally rural people have low income level due to lack of opportunities or any socio-economic activities. Nepal is a less developed country with a Human Development Index (HDI) of 0.428 (Human Development Report 2010) and per capita nominal GDP of USD 642. Most of the rural people's economy relies on agriculture. Commercial energy sources are out of reach for the rural people because of its fragile economy, absence of physical infrastructure, sparse population and lack of any opportunity. Hence, rural people are highly dependent upon less efficient traditional sources of energy such as fuel wood, agricultural residue and animal dung to meet their cooking, heating and agro-processing demand.

In regards Government of Nepal has set objectives of renewable energy development as "developing and expanding alternative energy as a powerful tool for alleviating poverty, raising purchasing power of the rural people by developing alternative energy technologies based on local resources, skill and increasing consumption of alternative energy and reducing dependency on imported energy by lowering the cost of installation through the proper utilization of local resources and means". Alternative Energy Promotion Centre (AEPIC)/National Rural and Renewable Energy Programme (NRREP) (2012-2017) emphasizes in renewable promotion and recognizes the role of renewable energy technology in the socio-economic development of rural people and aims 130,000 households biogas plants.

### **Background and the Present Context**

Biogas technology was started by Government of Nepal in 1975. This technology took further momentum in the country from 1994 following the establishment of Biogas Support Partnership, Nepal (BSP-Nepal) implements the technology in cooperation with Nepal Biogas Promotion Association (NBPA), an umbrella organization of 114 private sector biogas companies and 17 workshops that manufacture plant appliances and accessories (e.g. stoves, lamps, gas taps and dome gas pipes). NBPA provides skill-enhancement packages for masons and technicians, and

undertakes promotional work for the technology. Qualified biogas companies are responsible for plant construction and after-sales technical support. They also undertake a number of promotional activities.

AEPC was established in 1996 with an objective of disseminating and promoting renewable energy technology (RET) for improving living standard of rural people, providing the clean energy and conserving environmental degradation. BSP-N and NBPA came under the umbrella of AEPC after its establishment and the biogas technology has been implemented by BSP-N and NBPA since 2003. The following programmes highlight different phases in the biogas sectors:

- Energy Sector Assistance Programme (ESAP) was set up in 1999 till 2011 with the objectives of
  - I Phase (1999 - 2007): Institutional support to AEPC, investment support on Improved Cook Stoves, Microhydro, solar and rural electrification
  - II Phase (2007 - 2011): Setting up Rural Energy Fund, and support for biomass energy, solar and mini-grid
- After phase out of ESAP, NRREP (2012 - 2017) is formed focussing on
  - Setting up Central Renewable Energy Fund
  - Poverty reduction
  - Single programme modality
  - Business development and Productive end uses
- SREP (2013 - 2017) also came in existence at the same time with the emphasis on large size biogas plants categorically
  - Commercial
  - Local authority/municipal
  - Institutional and Community

With the support of GoN and external development partners, more than 350,000 household-size biogas plants have been installed in the country covering 70 districts. Various direct and indirect but important benefits enjoyed by the users of biogas technology play a significant role in the success of the sector. It is, therefore, imperative to know how far the users of biogas, who are the ultimate beneficiary of the sector, have derived benefit from their plants and the sector as a whole and to what extent they are satisfied with the technology. Investment subsidy by government and different organizations, loan at low interest rate and a long term repayment term by different banks are understood as other key elements for the success of biogas dissemination. However, the biogas plans and promotional incentives available were failing to convince and motivate the majority of rural farmers to adopt the technology as their primary source of household energy.

### **Private Sector Participation and Approach**



Implementation of a sensible and consistent subsidy policy combined with the development of liberalized policy and procedures for private sector participation triggered the entry of the private sectors in the construction of biogas plants. The biogas technology in Nepal has been implemented under a public private partnership (PPP) model. This successful model has been replicated in 21 countries of Asia and Africa. NBPA and BSP-N are strongly responsible for their role on PPP model. Nepal's private sector biogas companies are still at primary stage of development from the prospective of corporate culture and management. Both NBPA and BSP-N offer following strategic approach to address identifies triggering factor:

- **Partnership Strategy:** Both NBPA and BSP-Nepal firmly considers for healthy partnership and collaboration in development initiative and innovation by forging partnership with relevant stakeholders and actors in biogas sector.
- **Coordination:** Coordination is also important element for practicing good governance and it makes accountability to all stakeholders and discourages duplication of initiatives. It brings diverse stakeholder at all levels (Macro, Meso and Micro). Both NBPA and BSP-Nepal facilitate to diverse stakeholders constellation. This practice encourages identifying and prioritizing to real the multiple benefits from the biogas sector.
- **Advocacy, lobbying and social marketing:** With multiple reasons, advocacy and lobbying requires to promote, develop and use the biogas sector as an alternate source of energy in the rural, remote and isolated areas of the country. It supports to international campaign for poverty alleviation and to meet the millennium development goals.
- **Product Development:** BSP-Nepal and NBPA continue engage to develop new product, services and make improvement on the existing products or services based on the demand driven approach.
- **Replicating Best Practices:** Both organizations embark to diversify livelihood initiative by maintaining to efficient management practices, timely delivery program activities and replicating the best practices possible adjoin areas.
- **Institutional Strengthening and Capacity Building:** Strategic approach continues strengthening itself and its diverse partners through institutional strengthening and capacity building for sustained and continuously improved service delivery for the commercialization and for the sustainability of the sector.
- **Good Governance:** BSP-Nepal and NBPA follow further strengthen systems and practices for institutional and good governance for transparency and accountability.

### **Institutional Involvement and Working Modality**

Involvements of different institutions from public as well as private sectors have been contributing at various scales and capacities for the promotion of biogas. The emerging cooperation between these institutions exemplifies what one can call a best practice in

public-private-civil society partnership in community development. The public sector institutions include AEPC which is the main executing agency of biogas sector and is responsible for providing policy, coordination and monitoring support to execute the technology. On the other hand, NBPA and BSP-N have been the major promoter and implementer support from different external partners. In the private sector, different categories of institutions: Biogas construction companies and manufacturing companies which are prequalified by AEPC to participate in the technology. The relationship between the major institutions is shown Figure 1.

Currently, the relationship between key institutions involved in the biogas promotion under AEPC/NRREP framework as shown in the below figure. The Biogas Energy Sub-Component (BSC) of NRREP provides overall coordination and implementation support to institutions. The Central Renewable Energy Fund (CREF) administers the subsidy and credit for Biogas.

Apart from the major institutions mentioned above, a number of support organisations, civil society organisations, financing as well as academic institutions are contributing with their own scope and in their own capacity for the development of biogas in Nepal.

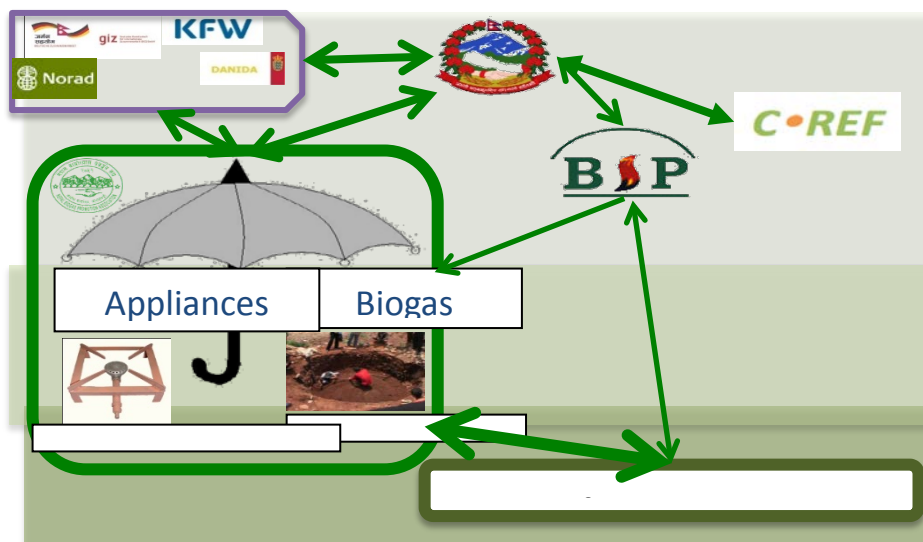

**Figure 1. Major Institutions involvement in Biogas Sector**

### **Achievement / Impacts**

Total physical achievement of the household biogas since 1994 has crossed the mark of 350,000 up to July 2015. The growth of biogas energy sector has made contributions at national as well as user level. It has provided opportunity to private companies for

investment, and generated employment thus contributed to poverty reduction. Furthermore, it has been instrumental in bringing about gender balance and has also contributed to social inclusion. Operation of household biogas has resulted into the following impacts on various sectors:

Year (1994-2015)	Total	Potential
Total no. of Biogas Installed	350,000	> 1.2 Million
Large Biogas Plant: Ranges from 10 m <sup>3</sup> to 300 m <sup>3</sup>	340	All Metropolitan and Municipalities
No. of Plants in CDM Projects	196,546	350,000
Total income from CDM Projects	US \$ 5.5 million since 3 years	
No. of Biogas Member Companies	114	145
No. of Manufacturer Companies	17	
Emission Reduction:	3 ton co <sub>2</sub> /per plant/per year	
Firewood Saving:	3.3 ton/per plant/per year	
Green Plant cutting saving:	2 green plants/per plant/per year	
Fertilizer Production:	2 ton/per plant/per year	
Time saving:	3 hours/per plant/per day	

**Figure 2. Achievement and Impacts of Biogas Development**

### Issues and Constraints

Geographical variability, poor social and economic infrastructure as well as weak governance are major issues and constraints which have been trigger to promote sustainability of biogas technology. The following issues and constraints in the sector are:

#### **Technical**

- Quality of construction materials and monitoring differ among the construction companies installing plants
- Poor performance as result of inferior construction materials, selection of wrong size and negligence in construction and operation
- Family size biogas plant yield low gas during winter and rainy season
- Problem of community sized plants related to ineffective management and sharing of benefit

#### **Financial**

- Biogas production is superior to direct burning of dung cake in term of energy utilization (thermal efficiency of 60 percent against 11 percent of dung cake), it can be only profitable and attractive for marginal farmers if the subsidy and credit are provided along with appropriate financing mechanism

- Biogas production will become more popular as fuel wood becomes scarcer

### ***Governance and Policy***

- Institutional gaps are the main bottleneck to promoting and carrying out the government policy and program smoothly
- There is no research and development institute to engage on developing cost-effective biogas plant sizes
- There is a need for a competent biogas and promotion unit with full fledged for overall policy and governance; monitoring & evaluation, capacity development to establish functional network to line and cross sectoral agencies
- Public private partnership initiative is poorly addressed

### **Lessons Learned**

As with all long running sectors, there have been following lessons drawn in terms of biogas technology:

- ***Government and development partner commitment***  
Biogas is one of the longest-running energy sectors in Nepal, largely due to on-going development partner support. This support has been encouraged by the GoN commitment, reflected in the increasing technical assistance to the private sectors and adoption of programme modalities within the national RE programme.
- ***Market promotion***  
GoN encourages private sector construction of biogas plants by means of subsidy, credit, market promotion and renewable of agreement and qualification.
- ***Ensuring quality service***  
Quality assurance system include: three to seven year guarantee on every biogas plant, after-sales service, user trainings, grading of biogas companies and strong, transparent policy of rewards and punishment for biogas companies. Guidelines include: Standardization of plant design, construction quality and quality of accessories and appliance and monitoring systems.
- ***Capacity development of stakeholders***  
Activities include: Capacity assessments, training and strengthening of the organizational structure, Masons, supervisors and Internal Quality Control Mechanism (IQCM) trainings, skills certification, market development and credit financing.
- ***Information dissemination***  
Information dissemination include: Enhancing accountability, generating demand in target areas, making plant economics comprehensible and relevant to users, investors and policy-makers and publicizing links between biogas and poverty alleviation.

Experience from the sector has also shown that biogas technology dissemination in Nepal need to come together to implement a fully functional market driven sector. The main influencing factors includes the affordability of the technology, clear boundaries of

responsibility and ownership of the programme, access to financial services and the influence of external development partner funding.

### **Conclusion and Recommendations**

Biogas energy sector is one of the effective and successful sector and is suitable and affordable to average Nepalese farmers. The biogas sector in Nepal is fairly strong in its institutional aspect with fairly good coordination with all stakeholders. NBPA and BSP-N work within setting institutional framework including the GoN, external development partners, companies, private sector and NGOs. These institutions effectively comprise a system of checks and balances, a pre-requisite for any successful biogas energy sector. NBPA and BSP-N have been instrumental in shaping the national policy and institutional framework with regard to promoting biogas in rural Nepal, including the establishment of the AEPC. NBPA and BSP-N have also been the first in Nepal to enter the CDM regime. In summary, private sectors like NBPA and BSP-N in Nepal provides a good example of a country-wide programme with a pro-poor and inclusive orientation operating through a market mechanism.

National physical target as well as budget allocation for biogas technology should be increased so that the capacity of private companies are fully utilised. Biogas technology is very supportive to women as well as children and it contributes to health and sanitation. However, it has not reached to the real poor and hence, it is recommended to provide the subsidy and soft loan to them. At present there is only a single GGC 2047 model biogas technology hence, it is necessary to conduct research on more efficient and cost effective designs. It should also focus on large size biogas plants using different feedstock and the gas to be used for power generation for income generating activities such as for rural electrification, pumping water or agro-processing.

### **References**

- *Publication: WECS 2010*
- *Publication: Human Development Report 2010*
- *AEPC web site: <http://www.aepc.gov.np>*
- *Biogas Year Book 2013*
- *Publications: Success Stories of Biogas Technology*
- *Biogas Programme Brochure*
- *Biogas: Annual Programme Report 2014 and Annual Programme Work Plan 2015*
- *NBPA (Nepal Biogas Promotion Association). 2007. Biogas sector in Nepal: Highlighting historical heights and present status. Nepal Biogas Promotion Association, Lalitpur, Nepal*
- *Publication: Making energy markets work for the poor: Large-scale dissemination of biogas plants*

## Design of Renewable Energy Data Measurement Instrument for Archipelago Area

Ibnu Kahfi Bachtiar, S.T., M.Sc.

Jurusan Teknik Elektro Universitas Maritim Raja Ali Haji

Jl. Politeknik Senggarang, Tanjungpinang 29100

e-mail : [kahfi@umrah.ac.id](mailto:kahfi@umrah.ac.id)

### Background

Province of Kepulauan Riau, Indonesia, is an archipelago area which still have very limited access to electricity. By around 2400 islands, 251,810 km<sup>2</sup> total area and total population 1.9 million people, conventional electricity generation, mainly by the diesel generator (PLTD), cannot fulfill the demand. The conventional centralized electricity generation does not fit geographical condition of the province, where 96% of its area is water.

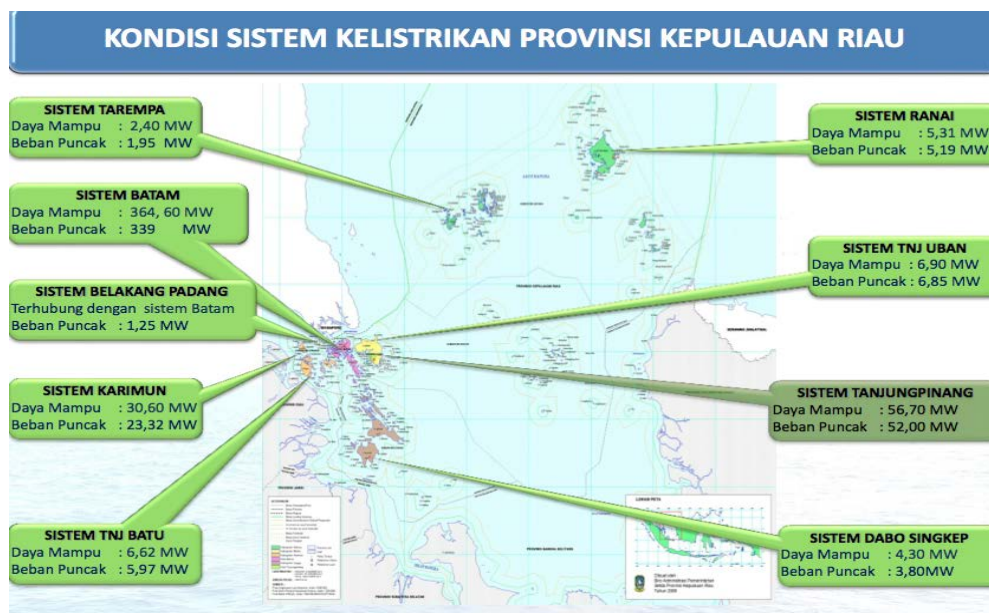

Figure 1. Electricity System in Prov. Kepulauan Riau (Bappeda, 2015)

The electrification ratio of the province is 74,06% (Bappeda, 2014), but it is noticed that 1.1 million people live in the big city island, Batam. There are still many isolated islands. Some small islands (hynterland) can only be supplied by diesel generator which operates in 7 hours and some can reach 14 hours. The cost becomes higher because the main transportation for fuel distribution is sea transport.

As the only state university in the Province, and the first and the only maritime university in the country, Universitas Maritim Raja Ali Haji gives strong attention to the research and technology development in the field of renewable energy. Though, renewable energy (RE) must be considered by the local government as a solution to this problem. One of the main issues in renewable energy generation is the availability of data, especially solar radiation and wind speed.

### Objective

This research works on designing instruments that consist of solar radiation sensor, wind speed sensor, datalogger for longterm measurement, and a user friendly interface software for datalogging evaluation and monitoring. A setup characterization instrument is also needed to test solar module and determine the I-V curve.

### Method and Results

The implementation of renewable energy in the Province of Kepulauan Riau needs some steps below.

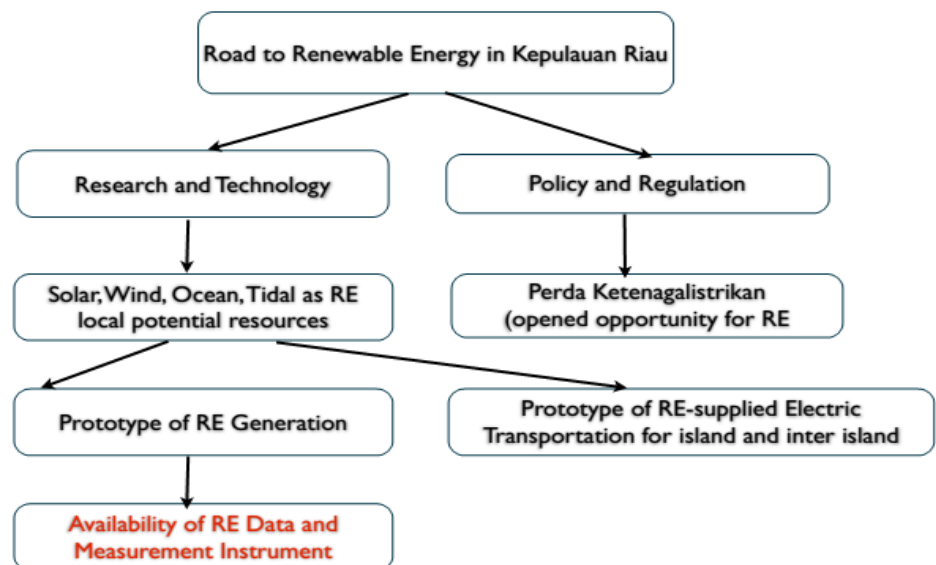

Figure 2. Road to Renewable Energy

The research going in Universitas Maritim Raja Ali Haji today focus in RE data measurement and build the system prototype. The main measurement instruments are solar radiation and wind speed sensor. There are several types of solar radiation sensor, but the cheapest one is made from photodiodes. Photodiode is a pn junction semiconductor device that convert light into voltage. A sensor consists of some photodiodes receive sunlight and then each output of the photodiodes enter the summing amplifier to get the average output voltage. From its sensitivity, the radiation in  $W/m^2$  can be calculated from the output voltage. The sensitivity of this sensor is  $0,834 \text{ mV}/Wm^{-2}$ .

Another sensor is cup anemometer. The anemometer was made from easy-found and cheap materials. The sensor designed to be practical and characterized by compare it to the commercial anemometer. Output from these sensors then processed by a datalogger and sent to a user terminal where a software interface already installed. The datalogger made using Arduino chip which is practical and easy to use. From this instrument, user can observe the data realtime and record it. All of the instruments were made practical and easy to carry which are fit to the condition of islands area.



Figure 3. Solar radiation sensor from photodiodes



Figure 4. Cup Anemometer and datalogger



The measurement took location in the city of Tanjungpinang, Province of Kepulauan Riau, around the campus area of Universitas Maritim Raja Ali Haji. The wind speed measurement range is 0-10 m/s with average wind speed 3-6 m/s. The solar irradiance at clear noon condition reach  $1000 \text{ W/m}^2$ .

A portable instrument that consists of those sensors was designed to mobility need. By using tripod, the sensors can be easily attached and carried to other area.

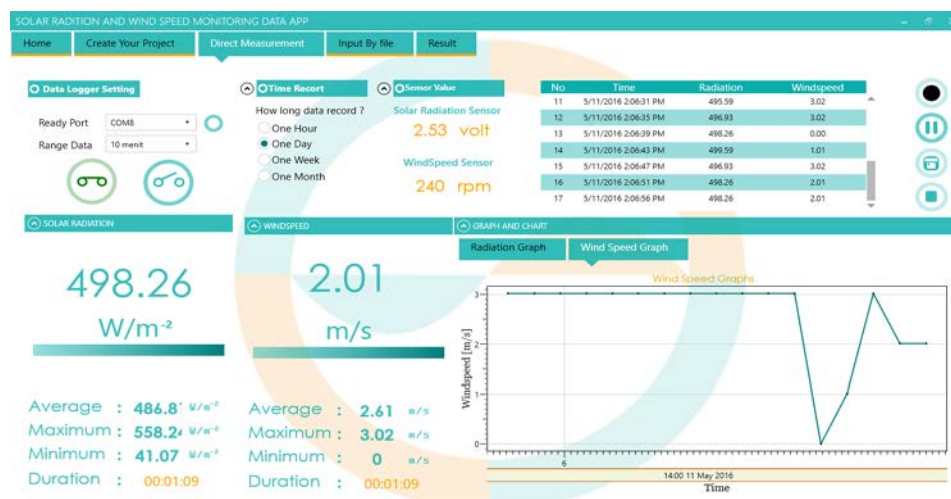

Figure 5. Monitoring Software

### Solar Module Characterization Instruments

The properties of a solar module can be characterized using a characterization instrument. The instrument was bulided using a sun simulator using halogen lamp. The light receive by the solar module is converted to voltage and in the condition of variable load-connected the current-voltage characteristic can be determined. This instrument can work for crystalline silicon solar module and thin film module. The setup can characterize modules up to  $200 \text{ W}_p$ .



Figure 6. Solar Module Characterization Instrument

### **RE development in UMRAH**

As the first and the only maritime university in Indonesia, Universitas Maritim Raja Ali Haji (UMRAH) has decided to focus in energy, transportation, IT, and culture. In energy, the research and development in the renewables is the main focus. The university has already installed 30 kW<sub>p</sub> on grid electricity generation from solar module, each 10 kW<sub>p</sub> from polycrystalline, monocrystalline, and thin film module. On the other side, there is also 10 kW<sub>p</sub> off grid electricity generation from thin film module. The wind energy converter also installed, consist of horizontal axis wind turbine totally 8 kW and the vertical axis 2 kW. The solar electricity generation designed as carport so that the area under modules can be used for parking.



Figure 7. Solar Module Carport in UMRAH

The solar electricity generation system also includes the battery charge controller unit and the monitoring system. By this monitoring, the output of the module can be observed real time and remotely access.



Figure 8. Total 8 kW wind energy converter HAWT

Even the average wind speed in Indonesia is not high, but for Tanjungpinang area, which is very close to the sea, the wind speed can reach more than 6 m/s, and in the north wind season, the speed can be higher.



Figure 9. The Controller Unit

Every wind turbine on the site can be controlled remotely by using this controller and monitoring system, include when the turbine should be braked because of the extreme wind speed.



Figure 10. Vertical Axis Wind Turbine 2 kW

## Remarks

Province of Kepulauan Riau, by 96% water of its area and archipelago can be seen as a miniature of Indonesia as an archipelagic country. The succeed in applying renewable energy (RE) in this area can be a good example for solving the energy problem in Indonesia archipelago. Some research and developments are still going in Universitas Maritim Raja Ali Haji as the only state university in this province, which focus in RE data mesurement, RE implementation and some system prototypes. By 2400 islands and the large water area, the centralized conventional electricity generation cannot sustain energy challenges in the Province of Kepulauan Riau so that self-powered by RE based on local resources is a fit alternative for many islands.

Some instruments designed to be fit for the geographical condition of Province Kepulauan Riau which is an archipelagic area. Solar radiation sensor and wind speed sensor in this research can be made from local materials, more economical, and easily use in the island area. The instruments are also accompanied by a self-designed datalogger and monitoring software to collect and observe the renewable energy data in real time and in long term. The characterization setup for test and determine the current-voltage characteristic from solar module is also available as a part of research instruments. Some renewable energy implementations in the Universitas Maritim Raja Ali Haji shows that this university is seriously work in the field of renewables and has installed solar electricity generation 30 kWp on-grid and 10 kWp off-grid. On the other side there is also wind energy converter which is consists of horizontal axis wind turbine which have total power of 8 kW and 2 kW vertical axis wind turbine. These developments as first step for UMRAH to be the center of excellence in the field of renewable energy in the national scale and south east asia region.

# Utilization of Jaboi Geothermal Resources by Using Binary Cycle Power Plant

Suardi Nur

Dinas Pertambangan dan Energi Aceh

Email : [suardi.nur@acehprov.go.id](mailto:suardi.nur@acehprov.go.id)

## Keywords

*renewable energy, geothermal, binary cycle, thermodynamic modeling, EES simulation.*

## Abstract

Currently, the electricity peak load in Sabang is about 3 MW which is supplied from diesel generator power plant. The electricity consumption is estimated 18 GWh/year. It is estimated the electricity consumption in next 5 years can reach 30 GWh. It is expected Jaboi geothermal resources which situated in Suka Jaya district could be utilized to supply this demand. However, the designing of power plant has to follow the growth of demand due to Sabang is isolated grid.

The system of Jaboi geothermal field is categorized as low enthalpy geothermal system which has temperature below 225°C and classified as water dominated systems. This conditions suit the binary cycle technology.

The conceptual model of binary cycle power plant for Jaboi geothermal field is proposed in this paper. The simulation is using Engineering Equation Solver (EES) to calculate the whole thermodynamics cycle of the system. The results show that to produce 5 MW gross power of binary cycle power plant will require 95 kg/s of geothermal flow rate which can be obtained from one production well.

## 1. Introduction

### 1.1. Jaboi Geothermal Prospect

Jaboi geothermal prospect is situated in Suka Jaya district, city of Sabang, Weh Island. Geographically, Suka Jaya is located between 95° 12' 00" - 95° 23' 00" E and 05° 46' 00" - 05° 55' 00" N. Weh Island is one of young volcanoes within western Indonesia volcanic arc which reaches from Sumatra, Java, Bali to Nusa Tenggara.

Reconnaissance exploration of Jaboi geothermal area started in 1972 with observation of the surface manifestation and geo-electrical surveys during 1983 and 1984. More geological survey was conducted in 2000. The integrated survey data (geochemical, geomagnetic, gravity, head on resistivity and geo-electrical) was compiled during 2005–2006 (Sumintadireja et al., 2010). It is estimated Jaboi geothermal field has 11.5 MWe of the possible resources (Castlerock, 2010).

Jaboi geothermal system is classified as water dominated system which has top reservoir around 600- 800 m depth (Dwipa et al., 2006)

## 1.2 Electricity Need in Sabang

Currently, the electricity peak load in Sabang is about 3 MW which is supplied from diesel generator power plant. The electricity consumption is estimated 25 GWh/year. However, It is expected the electricity consumption in next 5 years will be over 30 GWh.

Considering electricity system in Sabang is isolated system, which means the electricity production is unable to be transferred to another load area, therefore for the first phase it is proposed to design Jaboi geothermal power plant with capacity 5 MW.

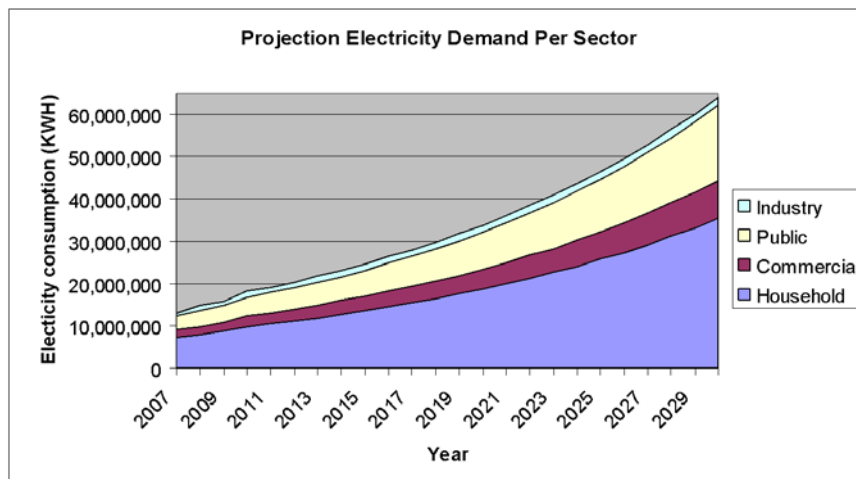

Fig.1. Electricity demand projection in Sabang

## 1.3 Thermodynamics Cycle Analysis

The binary cycle power plant basically converts the heat into the power from geo-fluid by using secondary working fluid, usually organic working fluid. The working fluid works in closed cycle. In certain boiling point, the working fluid will evaporate, expands through an expansion machine and releases enthalpy. The first geothermal binary power plant was installed at Kamchatka peninsula, Russia in 1967 with capacity 670 kW and served small village and some farms with both electricity and heat (DiPippo, 2008).

The design of binary cycle power plant needs to consider particular type of thermodynamic cycle, the pump and turbine the recovery of heat, condenser and cooling system. Fundamental variables in determining technical specifications of the plant are the geothermal fluid inlet temperature, geothermal fluid flow rate, well head pressure, rejection temperature and ambient temperature. Geothermal fluid temperature and flow rate are defined by characteristic of reservoir, sometimes can be modified by changing the depth of well. On other hand, the rejection temperature must be set properly in order to avoid the scaling problem. This problem can limit the complete utilization of geothermal resources (Franco et al, 2009).

### 1.3.1 Turbine Analysis

The turbine transfers part of the internal energy of pressurized working fluid steam into kinetic energy since the high pressure vapour of organic working fluid expands in the turbine. The turbine output can be derived from:

$$\dot{W} = \dot{m}_{wf} (h_1 - h_2) = \dot{m}_{wf} \eta_t (h_1 - h_{2s}) \quad \text{Eq. (1)}$$

Where

- $\eta_t$  is the isentropic turbine efficiency
- $h_{2s}$  is refers to the state of exhaust from ideal isentropic turbine
- $\dot{m}_{wf}$  is working fluid mass flow rate. The notation  $h_1$  and  $h_2$  are inlet and outlet of the turbine (see figure 2).
- $h$  is enthalpy

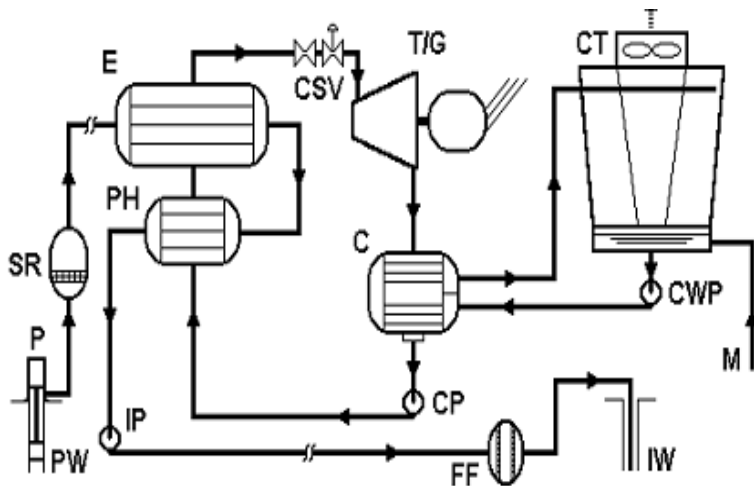

**Fig. 2.** Flow diagram of basic binary geothermal power plant. PW : production well, P : well head pump, SR : separator, E : evaporator, PH : pre-heater, CSV : control valve, C : condenser, T/G : turbine and generator, CP: feeding pump, CWP : cooling water pump, CT : cooling tower, M : makeup water and IW : injection well.

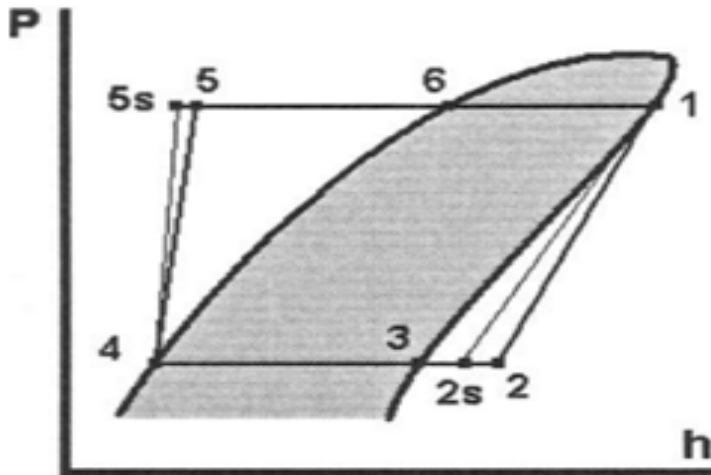

**Fig. 3.** Pressure – Enthalpy diagram in binary process (DiPippo, 2008).

### 1.3.2 Condenser Analysis

Condenser function is to condense the exhaust steam from the turbine. The performance of condenser will determine the efficiency of the power plant. The rejected heat from the working fluid to the cooling medium, water or air, can be calculated from:

$$\dot{Q} = \dot{m}_{wf} (h_2 - h_4) \quad \text{Eq. (2)}$$

The relationship between the flow rates of the working fluid and the cooling water is

$$\dot{m}_{cw} (h_y - h_x) = \dot{m}_{wf} (h_2 - h_4) \quad \text{Eq. (3)}$$

or

$$\dot{m}_{cw} \bar{c} (T_y - T_x) = \dot{m}_{wf} (h_2 - h_4) \quad \text{Eq.(4)}$$

where

- $\bar{c}$  is the heat capacity of cooling water
- $T_y - T_x$  is the temperature different at inlet and outlet of condenser.
- 

### 1.3.3. Feed Pump Analysis

The power consumed by feed pump to pump up the working fluid can be calculated:



$$\dot{W}_p = \dot{m}_{wf} (h_5 - h_4) = \dot{m}_{wf} (h_{5s} - h_4) / \eta_p \quad \text{Eq. (5)}$$

where

- $\eta_p$  is the isentropic pump efficiency
- $h_{5s}$  corresponds to ideal isentropic pump.

#### 1.3.4. Heat Exchanger Analysis

The two heat exchangers will be used as preheater and evaporator. The energy balance for these heat exchanger will be analyzed separately. In the analysis, it is assumed that the heat exchangers are very well insulated, therefore all the heat is transferred from geothermal fluid to working fluid (the heat loss is neglected). Other assumptions are mass flow rate is constant and the differences in entering and leaving potential energy and kinetic energy are negligible. Considering entire package as thermodynamic system, the relation between geothermal mass flow rate, and flow rate of working fluid can be seen in this equation:

$$\dot{m}_b (h_a - h_c) = \dot{m}_{wf} (h_1 - h_5) \quad \text{Eq. (6)}$$

According to DiPippo (2008), If the brine has low dissolved gases and solid, the equation may be replaced as:

$$\dot{m}_b \bar{c}_b (T_a - T_c) = \dot{m}_{wf} (h_1 - h_5) \quad \text{Eq. (7)}$$

where

- $T_a$  is the brine temperature at inlet
- $T_c$  is the injection temperature of brine.

## 2. Simulation Method and Assumption Used

The proposed concept is to design a typical binary cycle power plant with capacity 3 MW net power output. Since the stage of field development still in exploration phase, some required data i.e accurate brine temperature and well head pressure need to be assumed.

The model is simulated by using Engineering Equation Solver (EES) software. The simulation model is presented in Figure 4.

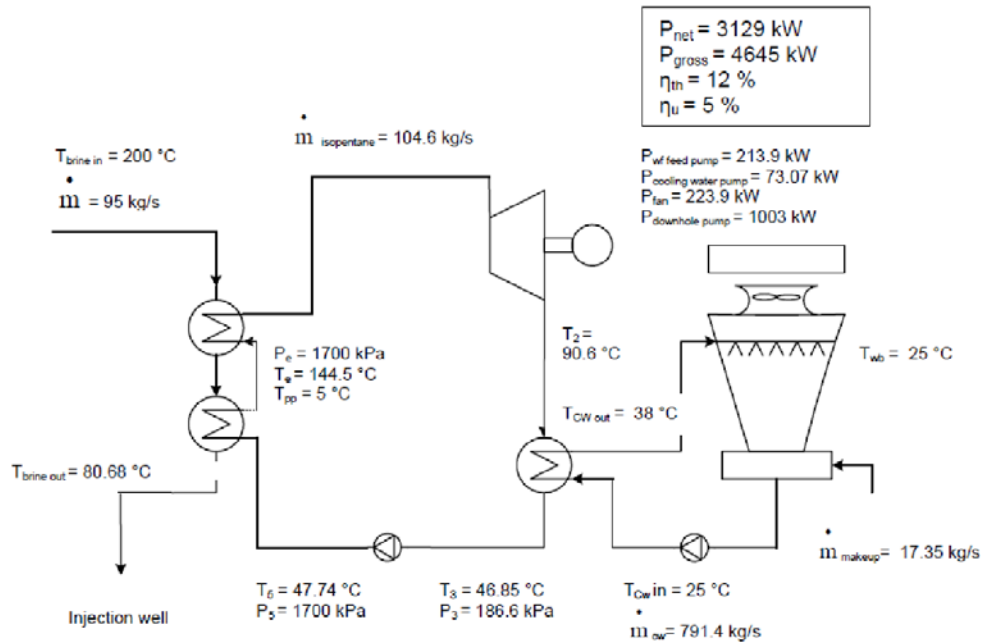

**Fig.4.** Model flow diagram

Isopentane will be used as secondary working fluid. The properties of isopentane which has boiling point at  $28\text{ }^{\circ}\text{C}$  and critical temperature  $187.8\text{ }^{\circ}\text{C}$ , is considered suitable to Jaboi geothermal resources.

## 2.1 Brine Temperature Estimation

The temperature of brine is estimated to be  $200\text{ }^{\circ}\text{C}$  which is obtained from around 1000 m drilling depth. The assumed temperature is estimated based on geothermal gradient profile.

$$\text{Geothermal Gradient} = \frac{BHT - MAST \times 100}{D} \quad \text{Eq.(8)}$$

Where ;

- $BHT$  is bottom hole temperature which is  $74.4\text{ }^{\circ}\text{C}$  (in 250 m depth)
- $MAST$  is mean annual surface temperature which is assumed  $25\text{ }^{\circ}\text{C}$ .
- $D$  is respective bottom hole depth in meter. The gradient is expressed in degrees centigrade ( $^{\circ}\text{C}/100\text{ m}$ ).

Thus, the calculation shows the temperature at 1000 m depth is  $200\text{ }^{\circ}\text{C}$ .

## 2.2 Well Head Pressure Estimation

The selection of well head pressure is very important in determining how much flow rate can be extracted from the well. In this simulation the well head pressure will be estimated 18 bars (or 1800 kPa) in order to avoid flashing of geothermal fluid in the surface plant equipment.

## 2.3 Assumption Used in the Model

Some assumptions used for modeling are described below.

1. Efficiencies ( Saadat et al, 2010 )
  - Isentropic turbine efficiency = 0.75
  - Feed pump efficiency = 0.8
  - Downhole pump efficiency = 0.75
  - Cooling pump efficiency = 0.8
  - Generator efficiency = 0.95
  - Cooling fan efficiency = 0.8
2. Minimum heat exchanger temperature difference ( $\Delta T_{pp}$ ) = 5 °C
3. Cooling tower
  - Raise of pressure on fan = 170 Pa (Valdimarsson, retrieved from Lukawski 2009)
  - Height of cooling tower = 1.5 m (Frick, et al, 2010)
  - Cooling water approach to wet bulb temperature 3 °C (El Wakil retrieved from Lukawski, 2009)
  - Raise of cooling water temperature in condenser = 13 °C (El Wakil retrieved from Lukawski, 2009)
    - Pressure losses = 1 bar (Frick, et al., 2010)
    - Rise of air pressure in the fan in cooling tower = 170 Pa (Lukawski, 2009)
4. Down hole pump
  - Production Index (PI) =  $160 \text{ m}^3/(\text{h} \cdot \text{MP}_a)$
  - Static fluid level ( $h_{\text{SFL}}$ ) = 295 m
  - Dynamic Fluid Level ( $h_{\text{DFL}}$ ) = 597 m
  - Friction loss = 10 kPa (Aksoy, 2007)
  - Diameter casing : 8.5 inch (Frick et al., 2010)

## 3. Results

### 3.1 Evaporation Pressure

The saturated vapor pressure of working fluid is designed at 1700 kPa. Based on the simulation of the model, at pressure 1700 kPa net power output gains maximum value. The

implementation of the pressure above 1700 kPa will decrease net power output. One of the reasons is because of the increases of auxiliary power demand of isopentane feed pump (see figure 5).

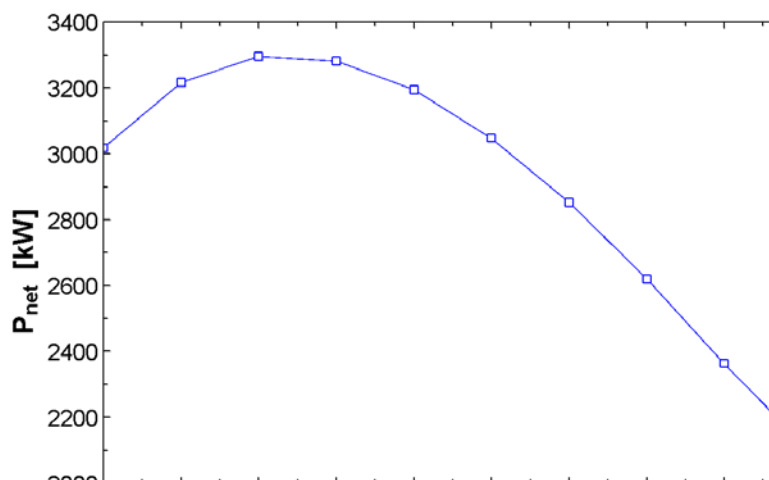

Fig. 5. Optimization of working fluid evaporation pressure

### 3.2 Brine Mass Flow Rate

The simulation of relationship between mass flow rate and power production is plotted in figure 4. The maximum flow rate of the well is assumed 160 kg/s and will produce around 5.5 MW of net power output. To produce 3 MW net power output (or around 4.6 MW of gross power), therefore a 95 kg/s mass flow rate of geothermal fluid should be able to be supplied from the well.

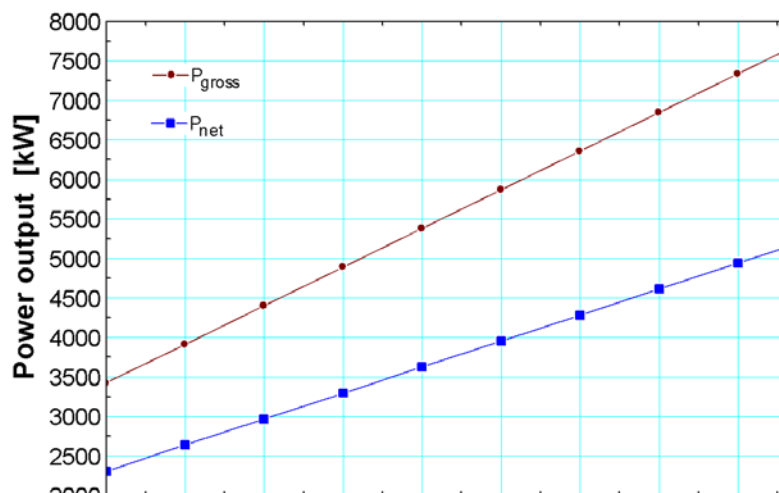

Fig. 6. Optimization of brine mass flow rate

### 3.3 Reinjection Temperature

The input of heat from geothermal fluid with mass flow rate 95 kg/s to raise the enthalpy of isopentane steam to 174.7 KJ/kg, preheater contributes 56 % of heat transfer to the isopentane (figure 7). The reinjection temperature is calculated 80.68 °C. Practically, the reinjection temperature is limited to the level where no scaling problem occurs in the injection pipeline. This limitation will limit the extraction of heat from geothermal fluid.

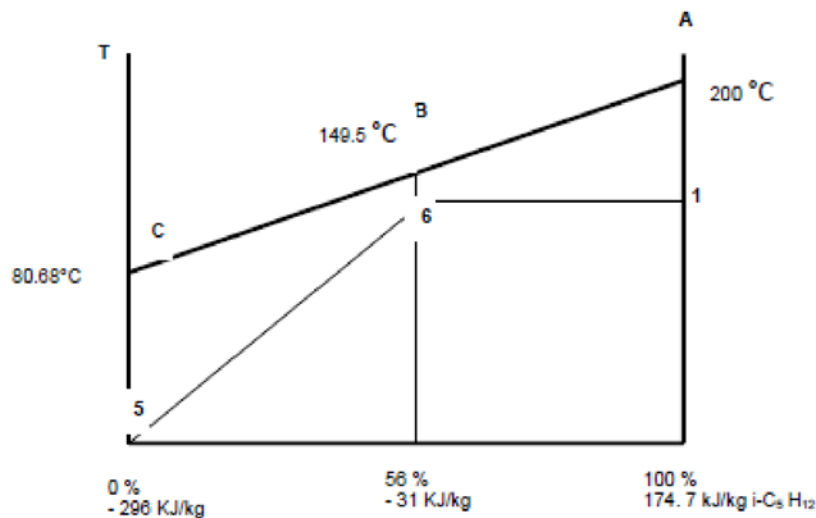

Fig. 7. Temperature – Heat Transfer diagram

### 3.4 Condensing System

The exhaust temperature of working fluid steam from the turbine is 90.6 °C. The steam flows through the condenser where it will be condensed by cold water with temperature 25 °C to temperature 46.85°C. After cooling down the steam, the heat rejected to cooling water is calculated 411.6 KJ/kg and the temperature of cooling water is raised to 38 °C.

### 3.5 Cooling System

The hot water is cooled again in cooling tower. The type of cooling tower used in simulation is induced draft type air cooling tower. The mass flow rate of cooling water is calculated to be 791.4 kg/s. To circulate this water it is required pumps with capacity 73.7 kW. In Integrated Pollution Prevention and Control (IPPC) 2001 European Commission reported the range of power consumption for the cooling water pumps varies between 5 – 20 kW<sub>el</sub> MW<sub>th</sub><sup>-1</sup> (Huenges, 2010). Due to the losses of cooling water, it is necessary to calculate the make-up water. In this case, it requires 17.35 kg/s of mass flow rate of make-up water. The pump power to pump the make-up water is calculated to be 2.17 kW. According to IPPC in Huenges (2010), the make-up water is about 1 – 5 % of cooling water.

The hot water entering the cooling tower is cooled through the heat exchange with cold air. The temperature of dry air ( $T_{db}$ ) is assumed as 30 °C which will be similar to the wet bulb temperature ( $T_{wb}$ ) when the relative humidity of the air is approximately 100%. The cooling

tower outlet temperature of air is raised to 35 °C. To induce 1533 kg/s of air, it requires 223.9 kW auxiliary power for fans. The power consumption of the fan varies between 5 – 10 kW<sub>el</sub> MW<sub>th</sub><sup>-1</sup> (Huenges, 2010).

### 3.6 Auxiliary Power Demand

Total auxiliary power demand is calculated 1516 kW or consumes around 32 % of gross power output. Net power output of power plant is calculated 3129 kW.

**Table 1.** Auxiliary power demand.

<b>Auxiliary power demand</b>	<b>Power Demand (kW)</b>
Downhole pump	1003
Working fluid feed pump	213.9
Cooling water pump	73.7
Make up water pump	2.17
Cooling tower fans	223.9
<b>Total</b>	<b>1516</b>
<b>Gross power</b>	<b>4645</b>

## 4. Conclusion

This paper is to propose new approach in developing geothermal resources in Indonesia as alternative to current common system. Binary cycle power plant commonly is used to utilize low and medium enthalpy geothermal resources. Jaboi geothermal field is expected to supply brine with temperature 200 °C which is obtained from 1000 m drilling depth.

The design approach is based on net power output instead of gross power output since the auxiliary power demand has major influence in determining the power plant efficiency. In this case, the auxiliary power demand consumes 32% of total power production. The auxiliary power demand varies according to specific site i.e downhole pump power demand will depend on its dynamic and static fluid level.

To produce 3 MW of net power output, it is required 95 kg/s brine flow rate which is highly possible to obtain from one production well. However, it hugely depends on specific characteristics of the geothermal site.

## References

DiPippo, R., (1999), "Small geothermal power plant. Design, performance and economics", GHC Bulletin.

DiPippo, R. (2008), "Geothermal power plants. Principles, applications, case studies and environmental impact" Oxford: Butterworth-Heinemann

Dwipa, S., Suhanto, E., Kusnadi, D., (2006), "Integrated geological, geochemical and geophysical survey in Jaboi geothermal field, Nanggroe Aceh Darussalam": Proc. 7<sup>th</sup> Asian Geothermal Symposium, China.

Franco, A., Villani, M., (2009), "Optimal design of binary cycle power plants for water-dominated,

medium-temperature geothermal fields", *Geothermics* 38 (4), S. 379–391.

Frick, Stephanie; Kranz, Stefan; Saadat, Ali (2010): Holistic design approach for geothermal binary power plants with optimized net electricity provision, World Geothermal Congress 2010, Indonesia.

Huenges, Ernst (2010), "Geothermal energy systems. Exploration, development, and utilization", Weinheim: Wiley-VCH.

Lukawski, Maciej (2009), "Design and optimization of standardized organic rankine cycle power plant for European Condition" University of Iceland and University of Akureyri, Akureyri, Iceland.

Niyazi, Aksoy (2007), "Optimization of downhole pump setting depths in liquid-dominated geothermal systems: A case study on the Balcova-Narlidere field, Turkey" *Geothermics* 36 (5), S. 436–458.

PT. Castlerock Consulting (2010), "Review and analysis of prevailing geothermal policies regulation and cost"

Pusat Sumber Daya Geology (2006), "Pemboran landaian suhu sumur JBO-1 dan JBO-2 daerah panas bumi Jaboi, P. Weh, Kota Sabang-NAD (in Indonesian language)", Subdit Panas Bumi, Indonesian Geological Agency.

Sumintadiredja, Prihadi, K., Suhanto, E. (2010) "Jaboi geothermal field boundary, Nanggroe Aceh Darussalam, based on geology and geophysics exploration data", Proc. World Geothermal Congress 2010, Indonesia.

## Purification of Bioethanol as Biofuel with Nanozeolite

Bambang Susilo\*, W.A.Nugroho\*, and Yusuf Khaharudin\*

Keywords : Bioethanol, nano-zeolite, isothermal adsorption

### Abstract

Biomass energy in the future will be the energy source that substitute or even replace petroleum for the internal combustion engine. Bioethanol is a biofuel that replaces the gasoline while biodiesel as a substitute for diesel oil. Bioethanol at this time are produced from the fermentation of mono- and di-saccharide while in the future more derived from the hydrolysis of long-chain carbohydrates as likes cellulose, ligno-cellulose and hemi-cellulose into simple sugars and then fermented into bioethanol.

The main problem facing the bioethanol converted to biofuel is the process of purification. Fermentation of mono and disaccharides produces high water content of bioethanol. It needs to be purified in order to be able to replace the gasoline. One technology of the bioethanol purification is distillation and dehydration carried out simultaneously. In this research, the purification by distillation together with dehydration is experimented using an inorganic adsorbent namely nano-zeolite 3Å (Angstroms) molecular sieve. The purpose of this study was to track the phenomenon of 3 angstroms nano-zeolites in the process of isotherms water adsorption in the purification of bio-ethanol. The absorption of water contained bioethanol using nano-zeolite 3 angstrom explains the phenomenon of water absorption under conditions of high bioethanol content.

The method used in this study is by setting the equipment that is able to make the vapor phase mixture of water-bioethanol pass through the nanozeolite. Bioethanol containing 85%, 70%, 65%, 40% and 55% of water base volume of 400 ml with three replications was evaporated and passed through nanozeolite placed on the tray in the equipment. Parameters measured include initial weight and weight of nanozeolites after the experiment as well as the water content of bioethanol after distillation passing nanozeolites. Data from this experiment are used to calculate the water absorption by nano-zeolites in grams of water per mole of zeolite. The differences between the initial and final mass is the mass of absorbed water.

The results showed the phenomenon trend of isotherms adsorption of water vapor on nano-zeolite phase 3Å is the Langmuir equation. Formulation of mathematical equations is  $q = 0.2881C / (0.940 + C)$ . Nano zeolite 3Å was able to increase the average concentration of ethanol 3.24%. The highest concentration of bioethanol that could be achieved in this study was 97.33% (% vol). This phenomenon explains the Langmuir trend that the real application of nano-zeolite 3Å always a great role in the purification of the ethanol levels beyond 90%.



## INTRODUCTIONS

Bioenergy is currently very intensively researched and applied. One type of bioenergy to replace conventional fuel is bioethanol.

Some industries have been producing fuel grade bioethanol (99.5% bioethanol) and used to substitute gasoline. Normally it is produced from molasses (Kausar, 2014) which is fermented by new strain of *Saccharomyces cerevisiae* B18 (Gumanti, 2015).

Purification of Bioethanol is processed in four stages namely : evaporation, distillation, dehydration and rectification. Evaporation stage produce 16% of ethanol. It is followed by purification with distillation column completed with some of tray. The tray is used to prevent water from passing through the instrument so that only methanol can escape to a distillation column. The tray serves also as a medium of contact between the vapor and liquid phases. The steam with high ethanol is able to pass the tray, but with lower ethanol contents is refluxed to be liquid phases. The next proces is dehydration to absorb excess of water after distillation (Khaharudin, 2014).

The type of adsorbent have a specific adsorption phenomenon and it is able to be illustrated in a graph of isotherms adsorption. The graph inform the characteristic of the absorbant. Special adsorbent to remove water called a dehydrator.

Dehydrator is currently widely used is nano-zeolite 3Å (3 angstroms). Diameter of alcohol and water respectively was 3.2A and 2.8A. Water will go into the pore of nano-zeolites because its diameter is smaller than the diameter of the nano-zeolites, while ethanol will not be absorbed by nano-zeolite because its diameter is greater than that of nano-zeolite (Fanani, 2012).

In this research, the phenomenon of water absorption in water-ethanol solution by nanozeolite 3 Angstroms was experimented and analysed. Trend phenomenon of isothermal adsorption by nano zeolite is analyzed in order to be applied on the purification of the bioethanol. By reconstructing the purification process of ethanol in the vapor phase, it will be known the phenomenon of removing water by nanozeolite 3 angstroms, so it can answer the question why the adsorption performed on a high ethanol content. This research could be as a reference for further study of the optimization of bioethanol purification as well.

- |                            |                                 |
|----------------------------|---------------------------------|
| a. temperature control box | h. coolant hose kodensor        |
| b. electric stove          | i. the stand condenser          |
| c. thermocouple            | j. receiver bottle              |
| d. evaporator              | k. the stand of receiver bottle |
| e. distillation column     | l. frame                        |
| f. connection 45°          | m. power cable                  |
| g. condenser               |                                 |

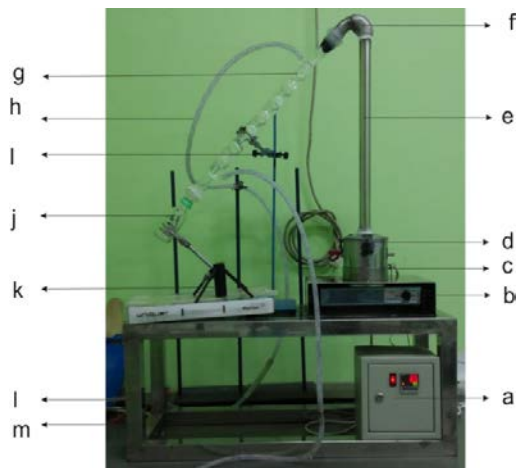

**Figure 1.** Purification Equipment Laboratory Scale Ethanol

## METHODS

The experiment was conducted in November 2015 in the Laboratory of Postharvest and Food Process Engineering (PHFPE), Faculty of Agricultural Technology, University of Brawijaya.

The materials used are ethanol 96% and then diluted with aquadest as a diluent to be 15, 30, 45, 60 and 75%. Absorbent material is nano zeolite 3 A passed with ethanol-water vapor mixture. setting the experiment is shown in Figure 1.

The diluent was heated in evaporator. The steam phase move from the evaporator to the condenser through the column. This column is equipped with a tray containing nano zeolite 3Å dehydrator. The tray is shown in Figure 2, while nano-zeolites are shown in Figure 3.



**Figure 2.** Tray

Steam with high ethanol content is passed to the condenser, while the water-rich vapor will hit tray and the water fall to the bottom (reflux). The remaining water is subsequently absorbed by Nano Zeolite.



**Figure 3.** Nanozeolite 3Å

### Data Analysis

The first is to study the isotherm trends phenomenon of nanozeolite 3 Angstroms. The initial stage is the search for the value of C (g water / g mol fluid) after a trays (without nanozeolite 3 angstroms). Considered value C when the gaseous and after condensation same. Five levels of ethanol is used as a reference to get the value of C with three replications.

The second stage is the search for the value of q (gr adsorbad / g adsorbent) using adsorbent nanozeolite 3 Angstroms. The first measured the initial mass nonozeolit 3Å. Refinery process is then performed to determine the value of q.

Five levels of ethanol used with three replications to get precision results. The mass of adsorbent nanozeolite 3Å was measured before and after the experiment. The difference between the initial and final mass is the mass of adsorbad and the q is able to be searched. The collected data is then processed to determine the isotherm shape of nanozeolite 3 angstroms phenomenon. This data is analysed descriptively for explain the adsorption phenomena.

## RESULTS AND DISCUSSION

### 1. Temperature (point) Boiling

Temperature measurement (point) boiling in this study was conducted to determine the energy required to boil the sample. Boiling point in this research is the temperature of the fluid in the evaporator is currently experiencing evaporation. Temperature can be known by three signs, namely :

- (1) The bubbles arise on the evaporator
- (2) ethanol condensate drips into the bottle;
- (3) The temperature is constant during the heating process.

**Figure 4.** shows the relation between concentration of ethanol and boiling point. The boiling point decrease because the boiling point of ethanol is lower than that of water, so the higher the concentration of ethanol then the lower the boiling point.

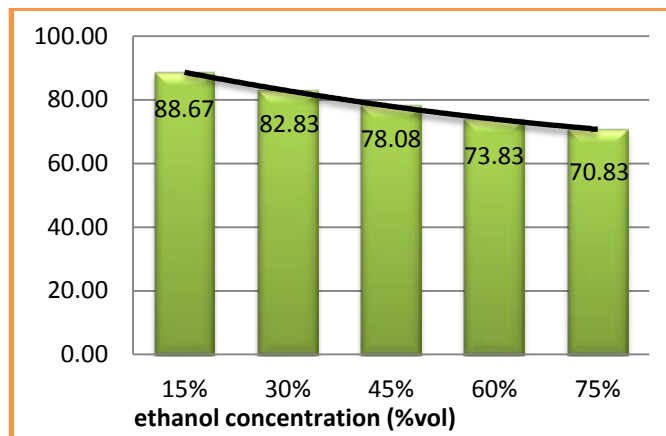

**Figure 4.** Boiling point of ethanol-water dilutions.

The relationship between the concentration of ethanol in the temperature boiling point ethanol-water mixture inversely. So this phenomenon can be interpreted that the higher the concentration of water, then the temperature (point) fluid boiling ethanol-water mixture is close to  $100^{\circ}\text{C}$  (boiling point of water). Vice versa, the lower the concentration of water, then boiling the fluid mixture with ethanol-water aka n approaching the boiling point of ethanol.

At a concentration of 15% ethanol (% vol) the mixture of ethanol-water boils at  $88.67^{\circ}\text{C}$ . While in 75% ethanol concentration (% vol), a fluid mixture of ethanol-water boils at  $70.83^{\circ}\text{C}$ . The boiling point of  $70.83^{\circ}\text{C}$  is lower than the boiling point of the fluid ethanol-water azeotrope which is about  $78.2^{\circ}\text{C}$ . Value  $70.83^{\circ}\text{C}$  is still in normal condition when correlated with geographic empirical phenomena and internal conditions among azeotropic ethanol-water mixture (Wolke, 1997; Doherty, 2001). The boiling point of the mixture can be used as an indicator composition of ethanol and water respectively in a fluid mixture of ethanol-water.

## 2. Ethanol Yields

Searches conducted to determine the concentration of ethanol  $3\text{\AA}$  nanozeolite influence on the quality of the ethanol yield. The quality of the results related to quality ethanol in water absorption. The quality of water absorption is affected by the surface area nanozeolite  $3\text{\AA}$ . According Ctrittenden et al. (1998), formed from the zeolite surface area of pores. for nanozeolite  $3\text{\AA}$ -shaped pellets of 3-5 mm (1/8 inch) has a surface area of  $135\text{ m}^2/\text{g}$  (Roelufsen, 1972). In this study, nanozeolite  $3\text{\AA}$  can absorb water about 2.1 gr / 10 gr nanozeolite  $3\text{\AA}$ . It will have great impact on the absorption of water when the form of nanozeolite  $3\text{\AA}$  has a smaller diameter. The smaller the size of nanozeolite  $3\text{\AA}$ , the greater the surface area. When the surface area is  $170\text{ m}^2/\text{g}$  (powdered or powder), then the water is absorbed is approximately 2.6 gr/10 gr nanozeolite  $3\text{\AA}$ . The consequences is that it led to levels of ethanol produced will be higher .

Concentrations of ethanol is able to use the value of SG (specific gravity) include the results of fluid purification. SG is also known as relative density which is variable without dimension. SG is the ratio of two densities, the denominator is the density of water at a temperature of  $4^{\circ}\text{C}$  and at a pressure of 760 mmHg (Doran, 1995; Pitts et al., 1977). As an example SG ethanol at a temperature of  $20^{\circ}\text{C}$  is 0.789. This value is obtained by dividing the density of ethanol at a temperature of  $20^{\circ}\text{C}$  ( $789\text{ kg}/\text{m}^3$  with the density of water at temperatures of  $4^{\circ}\text{C}$  ( $1000\text{ kg}/\text{m}^3$ ).

Ordinary calculations of derivative density formula can also be used to determine the concentration of ethanol in an ethanol-water mixture fluid. Values obtained using these different count value when compared using Table (empirical). This phenomenon shows that in the quest of ethanol to be no correlation between the mathematical calculation with empirical tables (Liu, 2006). As Wolke (1997) discussed, there is the phenomenon of volume shrinkage when ethanol and water are mixed. This phenomenon is caused by the determining of the ethanol concentration requires a mathematical calculation of correction factor with empirical data or available tables.

**Figure 5** presents a graph of the results of purification of the ethanol content. This chart presents a comparison between purification with and without nanozeolite 3Å.

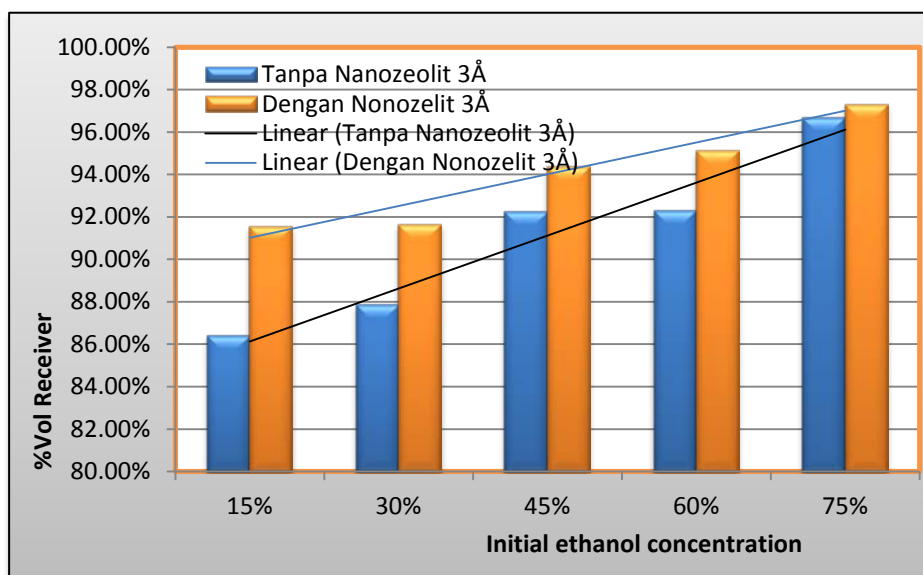

**Figure 5.** Consentration of Purified Ethanol

It illustrates that there are two phenomena that occur. The first is that the difference between ethanol concentration on the result of purification and concentration of ethanol in the initial conditions. This phenomenon can be seen in samples with low ethanol content (15%) without treatment nanozeolite 3Å resulted 86.44% and continue up to 91.56% in the samples with high ethanol content (75%). The treatment with nanozeolite 3Å has increased ethanol concentration from 91.56% to 97.33%. This phenomenon is caused by the ethanol molecule easy to evaporate. The ethanol molecules evaporate rates is twice of that of the water molecule (Wolke, 1997). Therefore, the higher the concentration of initial ethanol is evaporated, the higher the percentage of water evaporated.

The second phenomenon is that there is influence of nanozeolite 3Å on the ethanol purification. The experiments shows that the purification process of low ethanol concentrations (15%) produces ethanol concentration of 86.44% (without nanozeolite 3Å) and ethanol contents is 91.56% after treatment with nanozeolite 3Å. For the higher ethanol concentrations the nanozeolites have influence on the purification process as well. The initial concentration of 75% ethanol is purified without nanozeolite 3Å to be ethanol concentration of 96.71% and with nanozeolite 3Å to be 97.33%. Ethanol purification with nano zeolite 3Å raise the purity of 3.24% higher compared to the treatment without

nanozeolit 3Å. The highest ethanol concentrations were achieved in this study was 97.33%. This phenomenon shows that the nanozeolit 3Å is suitable for the end process of bioethanol purification.

### 3. Trend of isothermal Adsorption

Isothermal adsorption in this study is devoted to water absorption of fluids ethanol-water mixture with nanozeolite 3Å. The water is absorbed by nanozeolite 3Å in vapor phase, that obtained from the evaporation and distillation Ethanol Purification Equipment. The treatment is a reconstruction of refining ethanol on several Bioethanol plant in Indonesia.

Plotting the value of  $q$  and  $C$  will be obtained adsorption isotherm trend. relationship of  $q$  and  $c$  could be linearly but Freundlich describes the curve in the form of  $\log q$  with  $\log C$  while Langmuir describes the curve  $1/q$  with  $1/C$ .

Value of  $q$  is the ratio of the mass of absorbed water to mass nanozeolite 3Å (g water / g nanozeolite 3Å). Value of  $q$  is obtained from mass balance with nanozeolite 3Å treatment. The value of  $C$  is the mass ratio of a water mole to ethanol mol (gmol water / gram-mole ethanol). This value is obtained from the mass balance analysis.

Plot the data of  $1/q$  and  $1/C$  provides the best results in describing the phenomenon of water adsorption on 3Å nanozeolite vapor phase. Figure 6. shows the trends of Langmuir adsorption isotherm. According to Yang et al. (2010), Langmuir trend is the most excellent in explaining the adsorption experimental data of vapor phase.

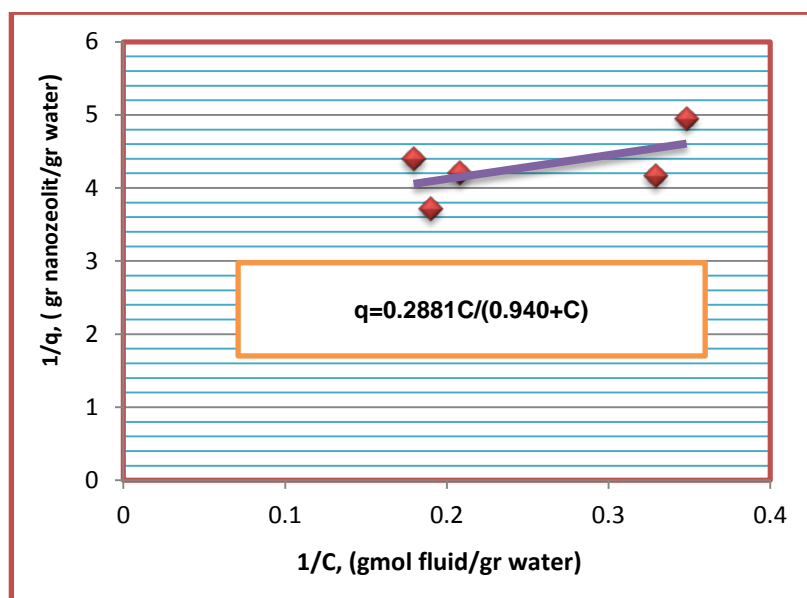

**Figure 6.** Langmuir adsorption phenomenon of isotherm water vapor phase

Figure 6. shows the trend of Langmuir phenomenon. It illustrates that the water is absorbed in a monolayer (single layer) on the surface of nanozeolite 3Å (Liu, 2006). This phenomenon illustrates that the water will be absorbed by nanozeolite 3Å included for the high ethanol concentrations. Thus nano-zeolites can be used for the purification of fuel grade ethanol (Khaharudin, 2014).

## CONCLUSION

The trend phenomenon of water adsorption isotherm in vapor phase 3Å zeolite nano is the Langmuir equation. Purification of ethanol with nanozeolite 3Å raise the purity of 3.24% higher compared to the treatment without nanozeolite 3Å. The highest value achieved in this study was 97.33% (% vol). The phenomenon of Langmuir trend explained that the real application of nano zeolite 3Å always plays important role on the purification of the ethanol concentrations more than 90%. Therefore, nanozeolite 3Å is very useful for bioethanol industry, particularly in the final stages of the purification process.

## BIBLIOGRAPHY

- Gumanti, A. 2015. Desain dan Optimasi Konsentrasi Sumber Karbon dan Suhu Pada Produksi Ethanol dari Molasses oleh *Saccharomyces cerevisiae* B18 Generasi-4 Expired Date Menggunakan Response Surface Methodology. SKRIPSI. FTP Universitas Brawijaya. Malang.
- Khaharudin, Y. 2014. Proses Distilasi Bioetanol di PT. Energi Agro Nusantara Gempolkrep, Kab. Mojokerto, Jawa Timur. PKL. FTP Universitas Brawijaya. Malang.
- Fanani, A. 2012. Pengembangan Pabrik Bioethanol Tuntaskan Destilasi, Evaporasi, Dan Product Daily Tank. PTPN-X magazine Volume:004 Th-II.
- Doran, P.M. 1995. Bioprocess Engineering Principles. Elsevier Science & Technology Books. ISBN: 0122208552.
- Pitts, D. R., dan L. E. Sissom. 1977. Heat Transfer. McGraw-Hill, Inc. Schaum Book Series.
- Crittenden, Barry dan W. J. Thomas. 1998. Adsorption Technology and Design. Elsevier Science & Technology Books. ISBN: 0750619597.
- Roelufsen, D. P. 1972. Molecular Sieve Zeolites – Properties and Applications in Organic Synthesis. Delftsche Uitgvers Maatschappi, N. V. DELFT.
- Liu, Yu. 2006. Some consideration on the Langmuir isotherm equation. *Colloids and Surfaces A: Physicochem. Eng. Aspects* 274 (2006) 34–36.
- Wolke, R. L. 1997. What Einstein Didn't Know: Scientific Answer to Everyday Questions. Dover Publicatin. New York. ISBN 979 22 0291 9.
- Yang, Qin dan H.J. Zhang. 2010. Discussion on the gaseous slip model based on Langmuir adsorption isotherm. *Physics Procedia* 32 ( 2012 ) 179 – 183

**CHAPTER 4. BUSINESS AND  
ENTREPRENEURSHIP MODELS FOR  
RESILIENT AND SUSTAINABLE ENERGY  
SYSTEMS**



# The Application of Balanced Scorecard In Business Canvas Model To Link The Sustainable Energy to Enterprise Strategies

Ali Mulyagusdin, SE, MBA, Ak, CA

UKM CENTER Fakultas Ekonomi Universitas Syiahkuala

mulyagusdin@gmail.com

## *Keyword*

*business and entrepreneurship models, sustainable energy, balanced scorecard, strategic planning*

## **Abstract**

Today, the environmental conditions have been in crisis. It is the result of human activities that use limited resources for unlimited needs. The habitants, day to day, strive to do the best in achieving their objectives without any regard to the sustainability of life itself. Innovation and technological capabilities of todays has led to the scarcity of resources, especially energy costs.

The lack of energy is the biggest concern for all of humanity. However, at a certain point, people cannot do much to change this situation for the better condition. Business and entrepreneurial activities are rarely looked at this issue as the main objective in their strategic planning.

The main key that increases the possibility to play the role in the business is how to build the strategic planning related to environmental sustainability. Using the Balance scorecard while building the earlier stage of business plan is very important. Balanced scorecard, that able to encourage enterprises to give the priority to non-financial benefits in generating revenue or even profit, is a strategic tool for the management and accounting in achieving business objectives. It becomes important to be applied in the building of environmentally friendly business model such as Business Canvas Model, especially in the non-financial considerations to bring financial benefits effect.

Thus, it is a tool that links the sustainability to enterprise strategy.

## **Introduction**

Globalization market trade drives the greediness of human. Which allows track the movement of goods, services, and money very quickly from one place to another and not only cross the line between countries but also continents. Globalization itself it cannot be avoided since this is a matter that has a positive value in the economic development of a region.

Competition economic growth across the company, interstate, inter-regional and also trigger competition machining technology usage that requires massive energy resources. The larger the target of production and trade is the greater the power consumption. It resulted in the use of energy from time to time continue to increase as well.

Indeed, we know, almost every nation in the world has been conscious immediately of implementing the use of renewable energy policy to ensure environmental sustainability and energy sustainability. Unfortunately, the use of technology for renewables is still in the category of expensive and difficult to implement. Regarding cost, it is company's' objective to increase the value, but not to increase cost and at the end have the high return for the certainty of business growth. Plus the lack of a state policy in this business is to implement renewable energy technologies. Not to mention the problems of the state itself, which may not have the human resources and budget, are sufficient to bring renewable energy sources.

For a company, the most important thing to be affected is when making of strategic planning. Strategic planning has a vision and mission that won energy sustainability is a workable solution for the short and medium term while waiting for a significant investment from the state or any other company for renewable energy technologies.

Making strategic planning usually starts with the creation of the business model of a company. With the Balance Score Card approach, the business model is built by a business entity enables the concept of sustainability into the strategic energy planning.

### **Economic Development and Sustainable Energy**

The energy consumption growth in the G20 slowed down to 2% in 2011, after the high increase of 2010. The economic crisis is primarily responsible for this slow growth. For Several years now, the bullish Chinese and Indian markets characterize the world energy demand, while developed countries struggle with stagnant economies, high oil prices, the resulting in stable or decreasing power consumption (Enerdata, 2012)

For environmentalists, the above fact is good news. But it is not for the developing countries. Furthermore, it is the bad news for companies that are pioneering efforts to survive their businesses.

As we know, the economic theory of Adam Smith's "The Wealth of Nations" states that every country would benefit from international trade. The key of this international trade is the specialization on products where the production efficiency is better than other nations, and making the international trade with other countries that have the ability to specialize in products that cannot be produced in the country efficiently (Smith, 1776). According to the theory, a state can be said to have an absolute advantage over other countries if these countries produce goods or services that cannot be produced by other nations. Competitive Advantages spur balancing market by using the power of investment, both sources of funds domestically or abroad. With the primary goal is to achieve equilibrium, where supply equals demands. However, we know the balance can never be reached by submitting pricing on the market mechanism. Because human nature to never be satisfied, so that always find a way with technological innovation to continue to rise. Again, it is faced with limited natural resources.

Formerly, energy is a limited natural resource. The human ability to search, explore, and produce energy since the industrial revolution up to now has been very high and right. So as to start looking and applying renewable energy technology to ensure the sustainability of energy is still a lengthy discussion. The reason for this rejection is that not enough science (know-how), high costs, the lack of policies or regulations that force the business to implement renewable energy technologies.

Despite the fact that positive economic growth does not go together with sustainable energy, but both the goal can be met at some points. The world of industry and entrepreneurship should implement energy management though at the lowest level, though. It is only possible if the energy management fit into their strategic planning.

### **Sustainable Energy**

Sustainable Energy is energy production and consumption are responsible for meeting the energy needs of the present without compromising the availability of energy in the future or harming the environment, these activities include energy efficiency (EE) and the use of renewable energy (renewable energy) (IFC, 2016)

Energy is the golden thread that connects economic growth, increased social equity and a healthy environment. The Sustainable Energy for All (SE4ALL) initiative, a partnership project between United Nations and World Bank, is helping to realize the vision agreed at Rio+20 by catalyzing major new investments, facilitating new public-private partnerships, and mobilizing bold commitments and actions that will have a transformative impact towards the achievement of three targets by 2030 (Dr. Kandeh Yumkella, 2016):

- Ensuring universal access to modern energy services;
- Doubling the global rate of improvement in energy efficiency; and
- Doubling the share of renewable energy in the global energy mix.
- 

**Sustainable energy** is providing sustainable energy to meet the needs of the present without compromising the ability of future generations to respond to their needs. Meanwhile, sustainable energy technology came from renewable energies, such as hydroelectricity, solar energy, wind energy, wave power, geothermal energy, artificial photosynthesis, and tidal power, and technologies designed to improve energy efficiency (OECD/IEA, 2016).

In this discussion, the two main pillars of sustainable energy are a renewable energy and energy efficiency. Renewable energy technology renewable energy technologies are essential to support sustainable energy because it is a source of energy supply security, as well as reducing dependence on fossil fuels such as petroleum and coal. According to the International Energy Agency, there are three generations of renewable energy within the last 100 years, namely: the first generation of renewable energy technologies emerging from the onset of the industrial revolution in the late 19th century. This first-generation technology is including the hydropower, biomass combustion and geothermal power and heat energy. Some of these technologies are still in widespread use today.

The second-generation renewable energy technologies include solar heating and cooling, wind power, modern bioenergy, and solar photovoltaic. This technology has now entered the market as a result of investment in research and development (R & D) undertaken since the

1980s. Investment in research is driven by the energy supply security concerns associated with the oil crises (1973 and 1979) (Pohekar & Ramachandran, 2003)

Third-generation renewable energy technologies are still under development and not yet entered the commercial sector. Including third-generation renewable energy technologies include advanced biomass gasification, bio-refinery technology, concentrated solar thermal power, thermal energy from the earth dry rock, and ocean energy. Besides their discoveries and advances in nanotechnology may also play a significant role in encouraging the development of third-generation renewable energy.

The first and second-generation technologies have entered the market and are widely used while the third-generation technology still relies heavily on research and development and long-term commitment of all parties, especially the government to encourage its use. For the case of Indonesia renewable energy is the energy source that is neither abundant real diversity nor availability. Few decades ago the availability of fossil energy in Indonesia was very rich both in petroleum, coal and gas. Currently, the availability of oil is already minuscule and Indonesia already entered the net oil import country for their ground oil consumption has exceeded domestic production. While coal is abundant also less precise management resulting in less added value nationally, especially in the equalization benefit. For Natural gas is abundant common that local needs energy deficit because most gas is sold abroad. It is time for the Indonesian government to apply the correct power management in the management and the application of renewable energy sources such as renewable energy and not the fossil. Do not get out faster fossil energy while national renewable energy system is still messy. We may experience the endless energy coal and gas as soon as exhaustion of petroleum energy. Because of the utilization of renewable energy nationwide should be faster. Target energy mix in accordance President Acts (Keputusan Presiden Republik Indonesia) No. 5 the year 2006 in which the renewable energy component is only 17 percent of the energy mix is too small because with this scenario nonrenewable energy too quickly only about 147 years of fighting to coal gas for 61 years and 18 years for petroleum. We must slow down rate of exhaustion of non-renewable energy by optimizing the technology soon-technology renewable energy above and increase the renewable energy mix target of national energy availability pad above 17 percent.

**Energy conservation** alone connote as an attempt to continue to use energy rationally but still maintaining productivity and fulfillment of the terms of corporate governance. Rational energy uses such as by saving and energy efficiency. So it must be distinguished between energy conservation with energy conservation. Reducing energy use can make the energy savings but does not confirm that the productions are down. While energy preservation in the implementation of the rules in the energy management does not only reduce energy consumption but also to implement a streamlined operation, installation of additional equipment which improves system performance so that power consumption is lower but does not reduce comfort and productivity. So in essence, energy conservation is a guide to how to save energy correctly and provides methods and tools that can be used a tool for energy savings without reducing productivity and comfort. Energy efficiency means the ratio between the energy usages of their products. So a high-energy efficiency means lower power consumption but high production. Thus, the concept of energy conservation is more spacious than the energy efficiency.

## The Application of Balance Scorecard in the Building of Business Model Canvas



### Perspectives

Adapted from Robert S. Kaplan and David P. Norton (Kaplan & Norton, 1996).

The balanced scorecard suggests that we view the organization from four perspectives, and to develop metrics, collect data and analyze it relative to each of these perspectives:

### The Learning & Growth Perspective

This perspective includes employee training and corporate cultural attitudes related to both individual and corporate self-improvement. In a knowledge-worker organization, people -- the only repository of knowledge -- are the main resource. In the current climate of rapid technological change, it is becoming necessary for knowledge workers to be in a continuous learning mode. Metrics can be put into place to guide managers in focusing training funds where they can help the most. In any case, learning and growth constitute the essential foundation for success of any knowledge-worker organization.

Kaplan and Norton emphasize that 'learning' is more than 'training'; it also includes things like mentors and tutors within the organization, as well as that ease of communication among workers that allows them to readily get help on a problem when it is needed. It also includes technological tools; what the Baldrige criteria call "high performance work systems."

### **The Business Process Perspective**

This perspective refers to internal business processes. Metrics based on this perspective allow the managers to know how well their business are running, and whether its products and services conform to customer requirements (the mission). These metrics have to be carefully designed by those who know these processes most intimately; with our unique missions these are not something that can be developed by outside consultants.

### **The Customer Perspective**

Recent management philosophy has shown an increasing realization of the importance of customer focus and customer satisfaction in any business. These are leading indicators: if customers are not satisfied, they will eventually find other suppliers that will meet their needs. Poor performance from this perspective is thus a leading indicator of future decline, even though the current financial picture may look good.

In developing metrics for satisfaction, customers should be analyzed in terms of kinds of customers and the kinds of processes for which we are providing a product or service to those customer groups.

### **The Financial Perspective**

Kaplan and Norton do not disregard the traditional need for financial data. Timely and accurate funding data will always be a priority, and managers will do whatever necessary to provide it. In fact, often there is more than enough handling and processing of financial data. With the implementation of a corporate database, it is hoped that more of the processing can be centralized and automated. But the point is that the current emphasis on financials leads to the "unbalanced" situation with regard to other perspectives. There is perhaps a need to include additional financial-related data, such as risk assessment and cost-benefit data, in this category.

### **Business Model Canvas**

The Business Model Canvas is a strategic management and lean startup template for developing new or documenting existing business models. It is a visual chart with elements describing a firm or product's value proposition, infrastructure, customers, and finances. It assists firms in aligning their activities by illustrating potential trade-offs. The Business Model Canvas was initially proposed by Alexander Osterwalder. It is based on his earlier work on Business Model Ontology. Since the release of Osterwalder's work in 2008, new canvases for specific niches have appeared, such as the Lean Canvas.

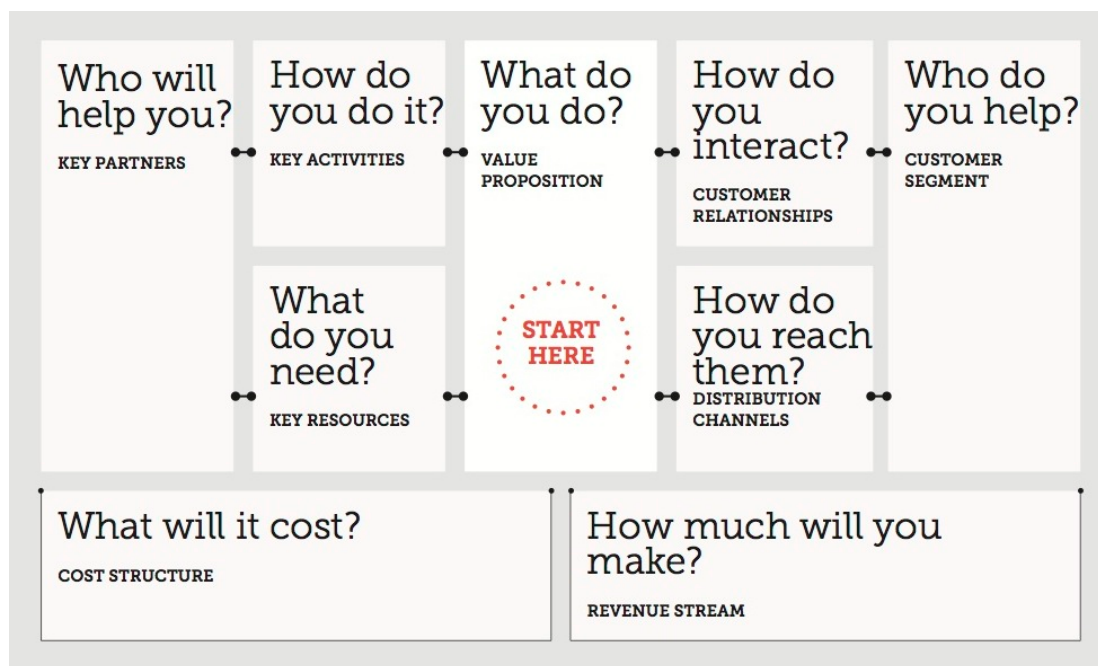

Source: (dytoolkit, 2016)

The suitable Balanced Scorecard model to Business Canvas Model is based on the third generation that a refinement of 2nd Generation design characteristics and mechanisms to give better functionality and more strategic relevance. Within 3<sup>rd</sup> generation, the 'Destination Statement' is initially found at the end of the design process to 'check' the objectives, measures and targets chosen. The first Destination Statements were created as a final consensus estimate of the consequences at a particular future date (e.g. 'in three years time') of implementing the strategic objectives previously selected for the strategic linkage model. By agreeing in this statement 'how much' of key things would have been achieved by this time (e.g. headcount, revenues, customer satisfaction, quality levels etc.) the hope was it would subsequently be easier (for example) to check for (or set) a consistent set of annual targets (Ronchetti, 2006).

<b>Financial and Market Characteristics</b>	<b>External Relationship</b>
<b>Activities and Process</b>	<b>Organization and Culture</b>

It was quickly found that management teams were able to discuss, create, and relate to the 'Destination Statement' much easily and without reference to the selected objectives. Consequently the design process was 'reversed', with the creation of the 'Destination Statement' being the first design activity, rather than a final one. Further it was found that by working from Destination Statements, the selection of strategic objectives, and articulation of hypotheses of causality was also much easier, and consensus could be achieved within a

management team more quickly. We will refer to Balanced Scorecards that incorporate Destination Statements as '3rd Generation Balanced Scorecards'.

Key components of a 3rd Generation Balanced Scorecard are:

- **Destination Statement:** In order to make rational decisions about organizational activity and not least set targets for those activities, an enterprise should develop a clear idea about what the organization is trying to achieve (Senge 1990, Kotter 1995). A destination Statement describes, ideally in some detail, what the organization is likely to look like at an Agreed future date (Olve et al, 1999; Shulver et al, 2000). In many cases this exercise builds on existing plans and documents – but it is rare in practice to find a pre-existing document that offers the necessary clarity and certainty to fully serve this purpose within an enterprise.
- **Strategic Objectives:** The destination statement offers a clear and shared picture of an organization at some point in the future, but it does not provide a suitable focus for management attention between now and then. What needs to be done and achieved in the medium term for the organization to “reach” its destination on time is agreed upon in the form of objectives or priorities. By representing the selected objectives on a “strategic linkage model”, the design team is encouraged to apply “systems thinking” (Senge 1990; Senge et al. 1999) to identify cause-and-effect relationships between the selected objectives i.e. what do we need to do to achieve the results we expect. This approach also helps ensure the objectives chosen are mutually supportive and represent the combined thinking of the team’s high-level perception of the business model.
- **Strategic Linkage Model and Perspectives:** The chosen strategic objectives are spread across four zones or ‘perspectives’. The lower two perspectives contain objectives relating to the most important activities in terms of business processes, cycle time, productivity etc. (Internal Processes) and what needs to happen for these processes to be sustained and further developed in terms of people, product and process development (Learning & Growth). The two top perspectives house objectives relating to the desired results of the activities undertaken i.e. how we wish external stakeholders (e.g. the general public, partner agencies and organizations to perceive us (External Relations) and how this will ultimately translate into financial results and economic value (Financial).
- **Measures and Initiatives:** Once objectives have been agreed measures can be identified and constructed with the intention to support management’s ability to monitor the organisation’s progress towards achievement of its goals (Olve et al, 1999). Initiatives are special projects with a finite start and end date and are mapped to strategic objectives to give an indication of the projects or actions needed in order to realize the objectives (Niven, 2002).

### Entrepreneur Model to Energy Sustainability

According to the above definitions and explanation, first of all, the model should create The Destination Statement that contain target of enterprise and providing the space to sustainable energy management. The most important thing that the companies should build the Standard Operational Procedures based on sustainability will change the strategic planning of enterprise, especially in pointing the customer segment, relationship, value proposition, key resources, and key partners.

Energy Objective:



1. Improve Assets Value and Reduce Operating Cost  
Maintain a portfolio of efficient, sustainable workspaces with comfortable conditions that enhance productivity, meet customer needs, and achieve financial objectives
2. Ensure every activity focus on sustainability  
Enhance, support, and guide the activity processes to ensure the activities are designed, constructed, commissioned, and operated with sustainability in mind.
3. Install renewable system and procure renewable energy technology  
Seek to influence the movement towards renewable energy sources by installing renewable systems and procuring energy from renewable sources.
4. Optimum the energy use  
Consistently implement demand reduction and energy conservation measures at our facilities.
5. Provide education  
Educate and involve employee, staffs, field worker, administrators, employee family, and visitors in our energy conservation efforts through awareness campaigns and other communication so they can make informed choices that have positive environmental results.

Key Partners	Key Activities	Value Propositions  <b><u>Deliver the eco-friendly process products and services to Customer</u></b>	Customer Relationships	Customer Segments
	Key Resources		Channels	
Cost Structure			Revenue Stream	

## Conclusion

- There is strong evidence that businesses are supporting by the situation of environment.
- Considering the balance scorecard variables in the building of business model brings the possibility to decrease the use of non-renewable energy and increase the advance technology to take the benefit of renewable energy.

- Building the Standard Operational Procedures based on sustainability will change the strategic planning of enterprise, especially in pointing the customer segment, relationship, value proposition, key resources, and key partners.

### Bibliography

Pohekar, S., & Ramachandran, M. (2003, September). Application of Multi-criteria decision making to sustainable energy planning - A Review. *Renewable and Sustainable Energy Reviews* .

Enerdata. (2012). *Sluggish growth of World energy demand in 2011*. Enerdata.

Smith, A. (1776). *An Inquiry Into the Nature and Causes of the Wealth of Nations*.

IFC. (2016). *International Finance Corporation Sustainable Energy Project*. Retrieved 2016 from International Finance Corporation: [http://www.ifc.org/wps/wcm/connect/60c211804b159ae5a9c4e908d0338960/Fact+Sheet+S+EF+Indonesia\\_bahasa.pdf?MOD=AJPERES](http://www.ifc.org/wps/wcm/connect/60c211804b159ae5a9c4e908d0338960/Fact+Sheet+S+EF+Indonesia_bahasa.pdf?MOD=AJPERES)

Dr. Kandeh Yumkella. (2016). *Concept Note Sustainable Energy for All*. Retrieved 2016 from Sustainable Energy for All Forum: [http://www.se4all.org/se4all-forum\\_concept-note](http://www.se4all.org/se4all-forum_concept-note)

OECD/IEA. (2016). *Media and Statistics*. Retrieved 2016 from International Energy Agency: [http://www.iea.org/media/statistics/Recent\\_Trends\\_in\\_the\\_OECD.pdf](http://www.iea.org/media/statistics/Recent_Trends_in_the_OECD.pdf)

Kaplan, S., & Norton, D. (1996). Using the Balanced Scorecard as a Strategic Management System. *Harvard Business Review* , January-February, 76.

dytoolkit. (2016). Retrieved 2016 from <http://diytoolkit.org/media/Business-Model-Canvasb.jpg>

Ronchetti, J. L. (2006). An Integrated Balanced Scorecard Strategic Planning Model for Nonprofit Organizations. *Journal of Practical Consulting* .

# Strategic Marketing Plan of LED Lamps towards Resilient Energy Systems

Esti Dwi Rinawiyanti\*, Benny Lianto, Novi Melsalina

University of Surabaya

\*estidwi@staff.ubaya.ac.id

The resilient energy cannot be only achieved through big project and complicated system, but also by the using of energy-efficient product. One example of energy saving product is LED light claimed to have longer lifespan and higher efficiency than most fluorescent lamps. Due to its potential market it is a chance to increase the usage of LED lamps in Indonesia. However, there is a strong competition because of some brands of LED lamps in the market. To fasten the diffusion of innovation LED lamps to be accepted by the extensive market, especially in Indonesia, this study was conducted to design the appropriate strategic marketing planning for LED lamps. Data obtained from survey that covers interview with the company and questionnaire distribution to actual consumers and retailers was processed to create some analysis, such as market analysis (market demand analysis, consumer analysis, and competitor analysis), strategic marketing plan and tactical marketing strategies. Based on the results of survey the appropriate strategy should be an offensive strategy that consists of a series of tactical marketing strategies: segmentation (geography and demography); targeting (middle-top household consumers); LED positioning (local brand lamps whose quality is not inferior to any other brand); as well as product differentiation and image differentiation. Marketing mix includes product (some wattage variation, longer warranty); price (discounts and competitive pricing); place (multi channel system), as well as the promotion (advertising, banners, sponsorship, and creating event).

## Keyword

LED lamps, strategic marketing plan, competitor analysis

## Background of the issue

Many countries give concern on resilient energy system that will lead to minimize the environment disruption and to reduce glass house emission. There are many ways for energy efficient, such as using energy saving lamps called LED (Neraca, 2013). An LED lamp is a light-emitting diode (LED) product which is assembled into a lamp (or light bulb) for use in lighting fixtures. LED lamps have a lifespan and electrical efficiency which are several times longer than incandescent lamps, and significantly more efficient than most fluorescent lamps, with some chips able to emit more than 300 lumens per watt (Wikipedia, 2016). The benefits of LED Lighting are endless: energy efficient (80-90 percent), long life span (up to

100,000 hours - more than 11 years), improved durability, low power consumption, compact size (smaller size), fast switching (instantaneous switch-on), brilliant and saturated colors, safety (operating at low voltage), and environmentally friendly (summarized from some internet sources). Because of its benefits the LED lamp market is projected to grow by more than twelve-fold over the next decade, from \$2 billion in the beginning of 2014 to \$25 billion in 2023 (Wikipedia, 2016).

LED lighting market has a bright future. Although there are fluctuations in the economy and the general lighting industry, LED lighting continues to acquire a significant part of the overall lighting market. It was projected that LED lighting market penetration will reach 31 percent of the \$82.1 billion global lighting market in 2015. Europe is the largest geographic market segment—accounting for 23 percent of the global lighting market share, followed by China at 21 percent and the US at 19 percent (LED Journal, 2015).

At the level of the Asia Pacific region, demand for LED lighting is also increasing. In 2012 the penetration of LED lighting in the area was still one percent compared to the population of all types of lamps. It is estimated that in following years LED market share jumped to sixteen percent. Indonesia is the largest market of LED lamps in Asia Pacific with an increasing number of consumers annually. Although the market share of LED lamps in Indonesia is less than one percent, but LED lights can be accepted by society in line with increased awareness on environmentally friendly technologies and better revenue (Marketers, 2013). It is also expected that the trend of energy saving lamps, i.e. LED, will increase in the future and are projected to reach 400 million units per year (Republika, 2011).

## **Objectives**

Nowadays there are several LED lamp brands in Indonesia, such as Nicolux, Philips, Osram and Chiyoda. As the follower Nicolux, as a local LED lamp, must cope with strong competition because the pioneer entered the market earlier and consumers already recognized their brands. However, based on secondary data, there are still many chances to increase the usage of LED lamps in Indonesia. Therefore this study was conducted with purposes: (1) to design the appropriate strategic marketing planning for Nicolux. (2) to achieve its competitive advantages through tactical marketing strategies. The more Nicolux is sold, the more consumers will be using LED lights that lead to energy savings towards resilient energy system.

## **Methods**

This research was started by a preliminary survey through observation and interview. The next step was data collection, both primary data and secondary data. Primary data was obtained through interview and questionnaire distribution to actual consumers and retailers of Nicolux. Secondary data was gathered through related institutions and internet. Software SPSS was needed to manage data and the results were used for further analysis that included strategic market planning (demand analysis, market analysis and competitive analysis) and tactical marketing strategies which covered the marketing mix (4Ps).

## Results

Results of data processing were used to generate some analysis as follows.

### Market Analysis

Market analysis was completed to estimate the demand of LED lamps and the variables of LED lamps considered important by consumers. It also describes the positioning of Nicolux in LED lamps market by comparing it to competitors.

- The demand analysis

The demand will be determined based on the secondary data obtained from internet as in the following:

- During 2012 Indonesia imported 250 million units of energy saving lamps from total demand of 320 million units. The national production of LED lamps should be 200 million units per year, but for this time being it is only 70 millions and the rest of 130 millions is fulfilled by import (Kementerian Perindustrian Republik Indonesia, 2016). It means that national producers can acquire only 20 percents of available market share.
- The lighting demand of household is 15 million units per year (Berita Satu, 2013). In Singapore LED lamps usage by household is 1:5 that implies there is one house that already use LED lamp among five houses. In China it can be 1:3. Therefore in Indonesia it is projected 1:15 that indicates one fifth of lighting demand can be converted to energy saving lamps (LED). Based on this assumption the estimation of LED demand is  $1/15 \times 15,000,000 = 1,000,000$  LED lamp units per year. It is a huge market. If Philips targeted to get 20 percent market share of LED lamps in Indonesia, there is still 80 percent market share that can be taken which is equivalent to 800,000 units per year.

Based on that information it can be concluded that there is still a big chance to sell LED lamps in Indonesia. Therefore Nicolux has an expectation to grab more market share.

- The consumer analysis

The consumer analysis was performed to identify variables of LED lamps that are considered important by customers. The scale of measurement as specified in Table 1 was created to simplify calculation.

Table 1. The measurement scale for the importance level and the satisfaction level

Scale	The level of importance and the level of satisfaction
1.00 – 2.67	Low
2.68 – 4.35	Medium
4.35 – 6.00	High

The average value of importance level of LED lamps variables can be seen in Table 2.

Table 2. The average value of importance level among 100 actual consumers

Dimension	Variable	Mean	Grand Mean per Dimension
Product	Brand	4.04	4.35
	Light quality	4.91	
	Warranty	4.87	
	Ease of warranty claim	4.41	
	Lamps colour	3.11	
	Watt	3.77	
	Durability	5.46	
	Service of complaint	4.20	
Price	Affordable price	5.08	5.06
	Discount	4.81	
	Competitive price	5.01	
	Price in accordance with quality	5.33	
Promotion	Advertising	3.93	3.90
	Banner	3.71	
	Brochure	3.49	
	Product knowledge availability	4.47	
Place	Product easily obtained	4.65	4.45
	Strategic location of retailers	4.25	

The price dimension got the highest importance level, then place, product, and promotion. But, based on the mean of each variable there were five variables with the highest importance level, i.e. durability, price in accordance with quality, affordable price, competitive

price, and light quality. Those results were supported by facts that LED lamps have longer lifetime than other lamp types and can reach 15,000 hours or more. The higher price of LED lamps than other lamp types will not be a problem for consumers as long as it matches to their good quality. However, consumers need affordable price and they will compare it to other lamps because they are likely to buy the cheaper ones.

Table 3. The average value of importance level among 21 retailers

Variable	Mean
Product sold in the market	5.52
Brand	4.38
Warranty	5.00
Affordable	5.29
Payment on credit	4.57
Respon to complaint	5.05
Promotion	5.00
Delivery	5.14
Product easily obtained	4.57

There are also some important variable of LED lamps considered by the retailers as shown in Table 3. There were four variables which got the highest mean: (1) product sold in the market, it means that retailers prefer to sell products that can be sold to end user consumers; (2) affordable price, in order to get high margin from the discrepancy between purchase cost and selling price; (3) delivery, the retailers expect the quick delivery to avoid stockout; (4) good response to complaint.

There are some differences between the importance level of variables between actual consumers and retailers as mentioned in Table 4.

Table 4. The mean of importance level between actual consumers and retailers

Actual consumers	Mean	Retailers	Mean
Durability	5.46	Product sold in the market	5.52
Price in accordance with quality	5.33	Affordable price	5.29

Affordable price	5.08	Delivery	5.14
Competitive price	5.01	Respons to complaint	5.05
Light quality	4.91	Warranty	5.00
Warranty	4.87	Promotion	5.00

It can be seen that actual (end user) consumers focus on variables related to product directly, such as durability, quality, price and warranty. But, the retailers give more attention on service given by company, such as delivery, response to complaint and payment. Nonetheless, there is similarity that both of them need warranty and affordable price.

- Competitive analysis

Competitive analysis is accomplished through competitive profile matrix (CPM) by comparing Nicolus with Philips and Osram. CPM is a matrix that identifies strengths and weaknesses of the main competitors against a company's strategic position. Critical success factors (CSF) in the CPM include external and internal issues. Thus, the rating refers to the strength and weaknesses, in which: 4=major strength, 3=minor strength, 2=minor weakness and 1=major weakness (David, 2007). The choice of the competitors was based on results of questionnaire which stated that most LED lamps used by actual consumers currently are Philips (56 percent) and Osram (19 percent), while the rest is another brand. Besides, the retailers stated also that LED lamps with the highest sales volume are Philips (76 percent) and Osram (12 percent), and another brands.

The comparison uses the important variables of actual consumers and retailers called critical success factor (CSF) with the results as on Table 5. It can be seen that LED Philips has the highest score (3.082), and then Osram in the second rank with score of 2.881, and the third rank is Nikolux with score of 2.563. It showed that Nicolus gets the lowest score compared to both competitors. Therefore Nicolus needs some improvements on CSF variables.

Table 5. Results of competitive profile matrix

CSFs	Wt	Nicolux		Philips		Osram	
		Ratin g	Wt'd Score	Ratin g	Wt'd Scor e	Ratin g	Wt'd Scor e
Product sold in the market	0.124	2	0.248	3	0.372	3	0.372
Brand	0.098	2	0.196	4	0.392	3	0.294



Warranty	0.112	3	0.336	3	0.336	3	0.336
Affordable price	0.119	3	0.357	2	0.238	2	0.238
Payment on credit	0.103	3	0.309	3	0.309	3	0.309
Response to complaint	0.113	3	0.339	3	0.339	3	0.339
Promotion	0.112	2	0.224	3	0.336	3	0.336
Delivery	0.116	3	0.348	3	0.348	3	0.348
Product easily obtained	0.103	2	0.206	4	0.412	3	0.309

### Strategic Market Planning

After defining market analysis, the next step is to determine marketing strategy. It is said that LED lamps has a chance to develop in the future. However, the competition in the market of LED lamps is very high. Based on CPM on Table 5 Nicolux obtains the lowest score than its strong competitors. It means that LED lamps market is attractive enough and Nicolux can apply offensive strategic market plan in order to grab more market share. Offensive strategic market plan is divided into two strategies, i.e. market penetration strategies and new market entry strategies (Best, 2000). Market penetration strategies are carried out to increase the existing market share and new market entry strategies relates to market development by entering new market. While there is still an opportunity to get more market share in Indonesia, the suitable strategy for Nicolux is market penetration.

### Tactical Marketing Strategies

The further stage is to design tactical marketing strategies that consist of segmentation, targeting, positioning, and differentiation, and also marketing mix (4 Ps).

- Segmentation and targeting

Segmentation of Nicolux is based on the geography and demography. A reason for geography segmentation is because nowadays Nicolux focuses on the market lamps in Indonesia to grab national market share. Demography segmentation is based on the social class of consumers. The target market of Nicolux is middle-top household consumers in East Java, Madura, and Bali that use LED lamps for household consumption.

- Product positioning and differentiation

Nicolux can apply positioning strategy "the same for the less". It is local LED lamp with similar quality with competitors but having a cheaper price. The differentiation is on the product itself with higher efficiency than others. It can also develop image differentiation with a perception that Nicolux relates to energy saving because of its superior efficiency and lower price.

- Product

Nicolux can consider the five variables that are considered important by actual consumers, i.e. durability, light quality, warranty, ease of warranty claim, and response to complaint. Indeed Nicolux offers core benefit as LED lamps for lighting. But, it can provide more value as actual product by developing some wattage variations, such as 5 watt, 6 watt, 8 watt, and so on. Furthermore, its warranty can be one year as an augmented product instead of only 6 months.

- Price

Price is considered significantly by actual consumers and retailers in choosing LED lamps. Therefore Nicolux can do some improvements related to pricing, such as giving discounts for big volume purchase, competitive pricing and value added pricing by setting higher price for more benefits.

- Place

Based on market analysis it can be recognized that product easily was important for actual consumers. Similarly, retailers considered that delivery is significant. This means that the location of the sale or distribution of Nicolux must be precise so that consumers can get it easily and retailers will have no problem with stock out. The mixed channel system can be suggested as collaboration between direct channel and indirect channel. Direct channel is accomplished through online via website and facebook and indirect channel is done through retailers. With those ways consumers can obtain the product easily.

- Promotion

Some effort should be carried out to communicate the product to consumers. Moreover, based on questionnaire results there was only 24 respondents among 100 respondents who ever heard about Nicolux and only 4 of 100 respondents use Nicolux. For that reason some suggestions should be done to generate the brand awareness of Nicolux. It can advertise the product through print media and electronic media. It can also put banners in front of the retailers. Moreover, it can create sponsorship on some events related to energy saving, such as Road Show Green n Clean collaborated with Surabaya Government. This event can be as media to inform product knowledge to public. The more consumers know about Nicolux, the more consumers who want to try it.

## Conclusion

Because of its benefits LED lamps usage in Indonesia is projected to grow. Most LED lamps current demand is covered by imported lamps. Therefore there is an opportunity for local manufacturer to fulfil the gap. As the follower, Nicolux, as a local LED lamp, should compete with some brands that are familiar and already recognized by consumers. Nicolux can choose offensive strategies to design strategic marketing plan and to implement tactical marketing strategies. From the analysis it can be suggested some improvements on variables considered important by actual consumers and retailers. Through the developments Nicolux will achieve competitive advantages and can deal with the tight competition very well. Those strategies can widespread the usage of LED lamps, especially in Indonesia, that can lead to energy saving.

## References

- Berita Satu (2013). *Penggunaan lampu led di property Indonesia masih minim*, <http://www.beritasatu.com/interior/134414-penggunaan-lampu-led-di-properti-indonesia-masih-minim.html>, accessed on 2<sup>nd</sup> May 2016.
- Best, R. J. (2000). *Market-Based Management*. Edisi 2. New Jersey: Prentice Hall, Inc.
- David, F. R. (2007). *Strategic Management: Concepts and Cases*. Edisi 11. New Jersey: Pearson Education, Inc.
- Kementerian Perindustrian Republik Indonesia (2016). *Indonesia impor 250 juta lampu tiap tahun*, <http://kemenperin.go.id/artikel/6194/Indonesia-Impor-250-Juta-Lampu-Tiap-Tahun>, accessed on 2<sup>nd</sup> May 2016.
- LED Journal (2015). *Global LED Lighting Trends Reveal Significant Growth and Product Development*, <http://www.ledjournal.com/main/blogs/global-led-lighting-trends-reveal-significant-growth-and-product-development/#sthash.97tdu6D2.dpuf>, accessed on 3<sup>rd</sup> May 2016.
- Led Lamps. (2016). *Benefits of LED lighting*, <http://www.led-lamps.net.au/led-basics/benefits-of-led-lighting>, accessed on 2<sup>nd</sup> May 2016.
- Marketers (2013). *Era lampu LED sudah dekat*, <http://marketeers.com/index.php/article/era-lampu-le-sudah-dekat.html>, accessed on 2<sup>nd</sup> May 2016.
- Neraca (2013). *Lampu LED pilihan cerdas menghemat energi*, <http://www.neraca.co.id/article/33135/lampu-led-pilihan-cerdas-menghemat-energi>, accessed on 2<sup>nd</sup> May 2016.
- Office of Energy Efficiency & Renewable Energy (2016). *LED lighting forecast*, <http://www.energy.gov/eere/ssl/led-lighting-forecast>, accessed on 3<sup>rd</sup> May 2016.
- Republika (2011). *Pasar lampu penerangan hemat energi capai 80 persen*, <http://www.republika.co.id/berita/trendtek/elektronika/11/12/02/lvklcy-pasar-lampu-penerangan-hemat-energi-capai-80-persen>, accessed on 2<sup>nd</sup> May 2016.
- Wikipedia (2016). *LED lamp*, [https://en.wikipedia.org/wiki/LED\\_lamp](https://en.wikipedia.org/wiki/LED_lamp), accessed on 2<sup>nd</sup> May 2016.

# **IDCOL: An Organization for Financing Resilient and Sustainable Energy Systems**

**Mir Tanweer Husain**

Sr. Asst Engineer, LGED & Member, TSC, IDCOL.

tanweer.husain@gmail.com

## **Keywords**

Organization, Finance, Renewable Energy, Resilient, Sustainable, System

## **Background**

Bangladesh is an energy starved country where only 55.2% population has access to electricity. (The World Bank, 2015) Its per capita electricity consumption is 259 kWh which is increasing at the rate of around 10% every year. (The World Bank, 2015) Generally, the people in remote area where conventional grid electricity is not available burn fossil fuel mainly kerosene for lighting purpose and pollute the environment.

## **Introduction**

Infrastructure Development Company Limited (IDCOL) is a state-owned financial organization involved in financing infrastructure and renewable energy projects in Bangladesh. The Company was licensed by Bangladesh Bank as a non-bank financial institution (NBFI) on January 5, 1998. Since inception, IDCOL is playing a key role in bridging the financing gap for developing medium to large-scale infrastructure and renewable energy projects in Bangladesh. The vision of the organization is: "To help in ensuring the economic development of the country and to improve standard of living of the people through sustainable and environment-friendly investments." (IDCOL, 2013-14)

## **Infrastructure Projects**

IDCOL provides long-term debt financing to viable privately-owned and operated infrastructure projects. To be eligible for IDCOL funding, projects must be included in the GoB's priority sector and use proven technology. Infrastructure sectors in the current priority sector include power generation, telecommunication, information and communication technology, ports, social infrastructure, gas and gas related infrastructure, water supply, toll roads and bridges, shipyards and shipbuilding, hotel and tourism, mass transportation systems, urban environmental services etc.

## Renewable Energy Projects

The renewable energy programs under IDCOL can be categorized into four major areas- Solar Home Systems (SHS), domestic biogas plants, Improved Cook Stoves (ICS), and small-scale renewable energy based power plants.

### Solar Home System (SHS)

With a view to provide clean electricity to the off-grid area of Bangladesh, IDCOL was engaged with Solar Home System (SHS) which are used mostly for lighting LED bulbs, operating DC TVs and mobile phone chargers. In 2003, IDCOL launched its SHS Program with a target to finance 50,000 SHS over five-and-a-half years with financial support from the World Bank and GEF. Fifty thousand SHSs were financed within three years – two-and-a-half years ahead of the schedule. A subsequent internal target was set for one million systems by 2012 – which was also fulfilled two years ahead of the schedule, by 2010. In the mean time, a number of development partners participated in the program providing loan and grant. Till now around 3.8 million Solar Home Systems (SHS) have been installed under the program providing clean electricity solution to 17 million rural people living in the off-grid areas of Bangladesh. Nowadays around 65,000 SHSs are installed in each month throughout the year with 58% yearly growth rate. Thus, the program has retained around 200,000 ton kerosene per year from burning and consequent emission of Green House Gases (GHGs). Besides, it has confirmed direct employment for more than 30,000 people. (IDCOL, 2013-14, p. 89) IDCOL's SHS Program has been recognized as is one of the fastest growing off-grid renewable energy programs in the world (Figure 1). It has a target to finance 6 million Solar Home Systems (SHS) by 2018. It has brought significant change of lives in remote rural areas of Bangladesh through providing access to electricity.

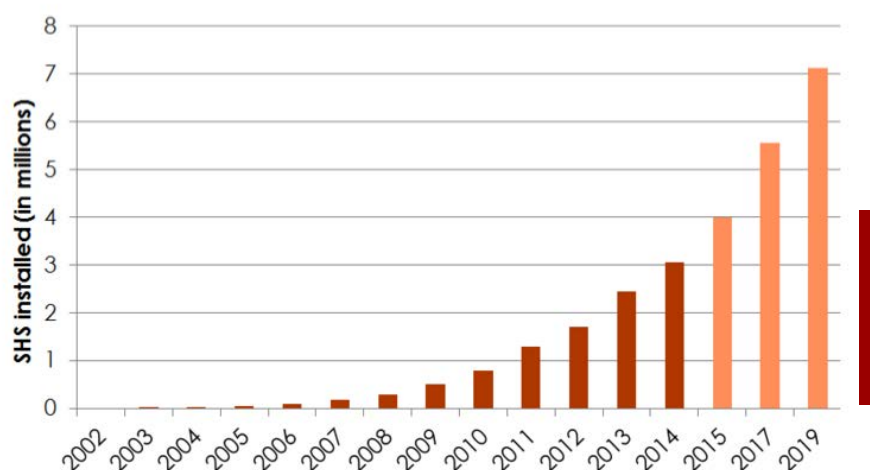

Figure 1. IDCOL SHS Program – Growth rates

The other programs of IDCOL in renewable energy sector are on Domestic Biogas, Solar Mini-grid, Solar Irrigation, Improved Cook Stoves, Energy Efficient Brick Kilns, etc.

### Domestic Biogas Plants

IDCOL started implementation of Biogas Program in 2006 as National Domestic Biogas and Manure Program (NDBMP) with the support from SNV, Netherlands Development Organization and KFW, German Development Bank. The World Bank joined the program

later on under its Household Energy Initiatives. IDCOL restructured the program in 2013 with the support from KFW and the World Bank. Under this program, IDCOL has financed construction of over 39,000 domestic biogas plants which provides clean energy solution to more than 196,000 rural people of the country. It has a target to install 60,000 domestic size biogas plants in Bangladesh by 2018.

### **Improved Cook Stove (ICS)**

IDCOL initiated the 'Improved Cook Stove (ICS) Program' in May 2013 with an objective to commercialize the ICS. It is expected that the program which would allow the ICS market to develop and flourish after the completion of the Program. IDCOL provides institutional development grant and technical assistance to its partner organizations (POs) under the program. IDCOL has thus so far achieved installation of 74,540 improved cook stoves. There is a target of 1 million ICSs installation across the country by 2018.

### **Other Renewable Energy Projects**

With a view to providing alternative means of electrification to the off-grid areas and to reduce pressure on grid electricity, IDCOL is also extending financing for other renewable energy projects such as solar irrigation pump, solar based mini/micro grid, biogas based power plant, biomass gasification, solar power telecom BTS etc. IDCOL has financed 445 solar irrigation pumps of which 188 are already in operation. IDCOL has approved financing for 16 solar mini-grid projects of which 7 are in operation and providing electricity in remote rural areas. IDCOL has financed 9 biogas based power plants, having total capacity of 618 KW. It has a target to finance 1,556 solar irrigation pumps, 50 solar based mini-grid and 60 biogas & biomass based power projects by 2018.

### **Resources**

IDCOL has proven itself reliable for receiving funds from different donors for different resilient energy programs. (IDCOL, 2015). It has been entrusted to access to resources from the World Bank (WB), Asian Development Bank (ADB), Japan International Cooperation Agency (JICA), German Development Bank (KFW), Department for International Development (DFID), Islamic Development Bank (IDB), German Development Cooperation (GIZ), United States Agency for International Development (USAID), SNV-Netherlands Development Organization, and also the Government of Bangladesh (GoB).

### **The Financing Model**

IDCOL implements their programs through 47 Partner Organizations (PO) consisting of Non-government Organization (NGOs), Micro-finance Institutions (MFIs) and other private entities. These POs receive financial as well as technical support from IDCOL. The POs set up SHSs, offer credit and provide after-sales service to the end users. IDCOL refinances a portion of the end user's loan amount to the POs and reduces POs' outlay on the system. This multi-party arrangement and contribution ensure punctual repayment of the loan and user's ownership of the system. (IDCOL, 2013-14, p. 89)

### **Ownership**

IDCOL's beneficiaries become owners of their SHSs, buying them outright in cash or, more commonly, after completing their installment payments. This encourages proper use and maintenance and confers the long-lasting benefits of solar-generated power to the system owner. Over-utilization of the SHS is minimized by limiting the capacity; the systems typically

can supply electricity for only 4 to 5 hours during the evening. The restricted usage diminishes demand for customer support and keeps systems running in good order. (Arc Finance, 2015)

### **Multi-Party Financial Contribution**

An important part of IDCOL's program is ensuring that customers as well as POs contribute to the installation costs of the SHS. To procure an SHS, a customer makes a minimum 10% down-payment to the PO. The remaining cost (90%) is a loan from the PO to the customer, who repays in installments. IDCOL refinances 70-80% of this loan amount, therefore reducing the PO's outlay approximately 18-27% of the SHS cost. This multi-party contribution ensures strong buy-in from all stakeholders, and aligns all three parties' objective: prompt and consistent repayment of the loan leading to ownership.

This arrangement incentivizes the POs to provide quality after-sales service. They need to ensure customers are satisfied, so that they repay their loans. The POs have to manage funds for their contribution to the systems' costs in order to manage further installations of SHSs and they also have to ensure a return on their equity contribution. Quality after-sales service is an important component of solar financing and serves as a marketing incentive as well. (Arc Finance, 2015)

### **Market Price Determination**

It keeps a keen eye on the competitive price and superior quality of the systems. Many programs fail because the market is controlled artificially or manipulated. IDCOL's approach is to allow market forces to determine the price of SHSs. While appealing in theory, the reality is that IDCOL continually monitors the prices that customers are paying as well as the component prices, and claims to require reasonable grounds for changes in SHS prices "without ever interfering in the determination of the price" – instead seeking competition between the POs and among equipment suppliers. Each PO has relationships with multiple suppliers for various SHS components, and POs are spread across the whole country. This is meant to ensure that all customers have access to a free and competitive market, on the basis of price, value, and quality of service.

### **Independent Selection**

Two autonomous committees select both POs and Suppliers based on set up criteria. The selection committees are comprised of professional, experienced people, working in relevant areas, who are not connected to either POs or suppliers, and whose only role is to provide secretarial support.

### **Indirect Subsidies**

IDCOL believes that providing a direct subsidy to the consumer is driven with complexity and risk. An indirect process is simpler for IDCOL as well as for the POs, and gives the POs "the sense of creating value and profit." In practice, IDCOL provides a small portion of the SHS cost as a subsidy to the POs for the sale of each unit, a subsidy intended to be passed-on to the customer. This subsidy is fixed for SHSs of less than 30Wp and is, at present, 12% of the SHS cost by weighted average. It is a progressive subsidy, meaning that poorer customers buying smaller systems benefit more from the grant support than wealthier ones purchasing larger systems.

Through subsidies, low-cost financing and competition among POs, the system automatically keeps small SHS prices from inflating. Because of the subsidy, POs can often price small systems lower than their actual purchasing cost, and they reduce the selling price as much as possible because of competition with other POs. Frequently, their lowest selling price will be equal to the purchase price minus the subsidy, and in this way the entire subsidy is passed along to the consumer. POs can afford to do this because they get their return primarily on the difference of the interest income (12-16%) on the loan that they offer and the interest at which that money is financed: IDCOL offers 6-9% financing for 70-80% of the loan that POs provide to their customers. (Arc Finance, 2015)

Thus, the role and activities of IDCOL and other stakeholders including Donors, NGO/PO, Suppliers, different Committee and End-users can be shown in the following diagram:

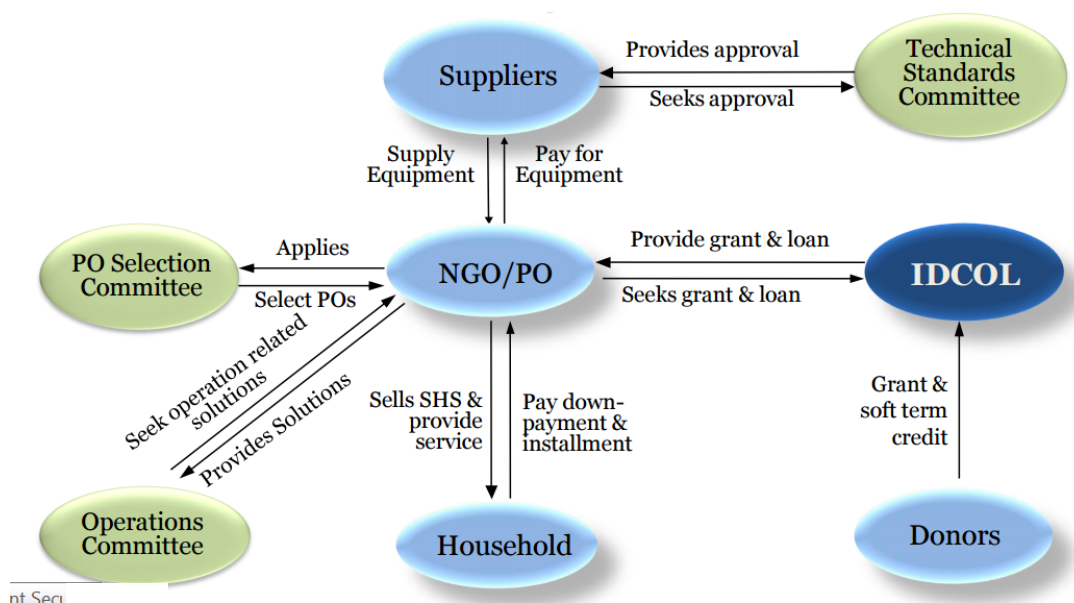

### Environmental and Social Management Framework (ESMF)

In general, the renewable energy projects like Solar Home System (SHS) and other renewable energy component including mini-grid, solar irrigation, domestic biogas, improved cook stove, and biogas/biomass gasification based power projects are environmentally friendly by nature. However, with a view to the sustainable development, an Environmental and Social Management Framework (ESMF) has been developed for IDCOL's renewable energy projects. The ESMF guides as well as ensures that the interventions have not contributed to any degradation of environment and society.

### Environmental & Social Concern

The manufacturing, operation and finally disposing off the equipments are screened out for checking the environmental & social hazardous impact. A major environmental concern is the emission of Lead Oxide (PbO), Hydrogen Sulfide (H<sub>2</sub>S) and other gaseous substance during the Battery manufacturing and recycling process for SHS. At the operational stage of SHS, there is some emission of Sulphur Dioxide (SO<sub>2</sub>) and other gaseous substances.



Disposal of the expired PV panels composed of Silicon, Aluminum, Hydrochloric Acid and Phosphine is also a concern from environmental point of view.

In the context of social safeguard, IDCOL does not undergo projects requiring land acquisition or relocation of people from their private or public land. It deals with the Indigenous Populations (IP) with special attention. Consultation with the IPs is done in their local languages ensuring that they are able to understand and express properly.

### Potential Impacts and Mitigation Measures for SHS

Potential Impacts	Mitigation measures
<b>Inappropriate management of expired batteries</b>	<ul style="list-style-type: none"> <li>● Developed a “Policy Guidelines on Disposal of Warranty Expired Battery” which the customers, POs, and manufactures have to comply fully.</li> <li>● Developed a tracking mechanism for disposed off battery.</li> <li>● Engaged Inspectors in regional offices to monitor the management of expired battery.</li> <li>● Introduced financial incentive for POs and recyclers for properly recycling the expired battery.</li> </ul>
<b>Significant risk of environmental and health safety hazards during manufacturing of lead-acid battery</b>	<ul style="list-style-type: none"> <li>● The battery suppliers and expired battery recyclers under SHS program need to comply with ISO 14001:2004 and OHSAS 18001:2007 in addition to the requirements of the DOE.</li> <li>● Organizes meetings / workshops regularly for raising awareness on Environment and Health Safety (EHS) compliance and monitoring the implementation standards of EHS.</li> <li>● Installation of Effluent Treatment Plant (ETP) and Air Treatment Plant (ATP) has been mandatory for its enlisted battery suppliers and expired battery recyclers.</li> </ul>

(IDCOL, 2016)

## SWOT Analysis of IDCOL

### **Strengths**

- IDCOL is the market leader in the infrastructure financing sector which enables it to operate in a large scale while enjoying significant economies of scale.
- IDCOL provides concessionary financing and channels grants to eligible projects
- An efficient and experienced group of employees ensuring faster response to the development initiatives from different sectors.
- IDCOL is the only organization in Non-bank Financial Institution (NBFI) sector that provides foreign currency loan.
- Specialized knowledge base in infrastructure and renewable energy sector.

### **Weaknesses**

- Due diligence process required by IDCOL for rendering approval of a particular project which is relatively rigid than other organizations.
- Highly dependent on foreign development appraisal process organizations such as the World Bank, KfW, GIZ, ADB, IDB, GEF, GPOBA, USAID, DFID, JICA, SNV, etc.
- Renewable energy technologies such as solar mini-grid, solar irrigation, biogas based electricity plants are still unfamiliar and unverified to the people.

### **Opportunities**

- Its programs are in line with the Government's vision of "Electricity for all by 2021", including 10% from renewable sources
- New concepts like carbon financing have huge potential for investment in Bangladesh through IDCOL.
- International donor organizations are interested to finance Bangladesh for development projects.
- Traditional sources of electricity like – gas and coal are going to be depleted in future, boosting up the need for more renewable energy in coming years.
- The Government's interest on Public Private Partnership (PPP) presents opportunities for IDCOL to invest through PPP.

### **Threats**

- Though there is no difference that private sector involvement is important to infrastructure development in Bangladesh, the coordination among public and private sectors still remains a challenge.
- Local currency loans are often too expensive and offered for too short period.
- Natural gas, the primary raw material for power plants and many such infrastructure projects, is scarce in our country. According to Petrobangla, natural gas reserve is likely to be depleted by 2020.
- In the renewable energy sector, one major challenge is high upfront investment cost. IDCOL teams of solar energy and irrigation engineers working on strategies to reduce this cost and make it more affordable to end users.

- Renewable energy projects require high grant support to become competitive with fossil fuel based technologies which is unsustainable in the long run.
- In today's economy, Foreign Direct Investment (FDI) in the country is very low due to political instability indicating political threats.
- New players are emerging in the field of private sector infrastructure and renewable energy financing.

## Conclusion

At present, IDCOL is a leading organization in private sector energy and infrastructure financing in Bangladesh. Utilizing the available strength and opportunities, now the organization is ready to escalate its investment horizon embracing more infrastructure and renewable energy sector projects. With due concern on the existing threats and weakness, IDCOL is scaling up renewable energy programs for providing an affordable and environment friendly energy solution for the rural poor. Thus, IDCOL has been instrumental in bridging the financing gap in renewable energy projects which is replicable to other countries of the world to promote and disseminate resilient and sustainable energy for development.

## Bibliography

Arc Finance. (2015). *Going "All in" on Solar Finance: How IDCOL Incubates a Growing Industry in Bangladesh*. Retrieved from Arc Finance: <http://arcfinance.org/news/blog/going-all-in-on-solar-finance-how-idcol-incubates-a-growing-industry-in-bangladesh/>

IDCOL. (2013-14). *Annual Report*. Dhaka.

IDCOL. (2016). *Annual Report 2014-15*. Dhaka.

IDCOL. (2015). *Projects and Programs*. Retrieved from IDCOL: <http://idcol.org/home/pandp>

IDCOL. (2015). *Vision, Mission, Core Values*. Retrieved from Infrastructure Development Company Limited (IDCOL): <http://idcol.org/home/mission>

The World Bank. (2015). *Data - Access to electricity (% of population)*. Retrieved from The World Bank: <http://data.worldbank.org/indicator/EG.ELC.ACCS.ZS>

The World Bank. (2015). *Data - Electric power consumption (kWh per capita)*. Retrieved from The World Bank: <http://data.worldbank.org/indicator/EG.USE.ELEC.KH.PC>

## Accelerated Commercialization of Photovoltaic Water Pumping System in Nepal

Resha Piya Shrestha

Winrock International

[reshapiya@gmail.com](mailto:reshapiya@gmail.com)

### Keyword

Agriculture, Market system, Supply chain, PVWP, irrigation, framers, business model, financial model, AC-PVWP, KISAN, financing institutions

### Background of the issue

Agriculture remains Nepal's principal economic activity, employing more than 70% of the population. Despite this, since agriculture sector is mostly subsistence, it contributes only about 35% to the total GDP. The country is dominated by rain fed agriculture, therefore, the majority of the farmers still rely on rainwater for irrigation. Rural framers in the country need reliable, low-cost water pumping solutions so that they can grow crops and vegetables even in dry seasons to increase their food security as well as their income. The smallholding farmers' usually do not have access to services provided by bigger scale irrigation systems, therefore as an alternatives to water supply during dry season these farmers either use diesel or electricity based water pumps for agriculture purposes.

However, climate change acclaimed rainfall's seasonal variations, continuous crisis in fuels supply resulting in high price of diesel and severe load shedding with limited access time to electricity resulting in intense limitations in using these water pumps. Current pumping practices are unreliable or are too costly in the long-run. Use of Photovoltaic Solar Water Pumping System (PVWP) can ensure year-round irrigation resulting into multi-crop production. Although PVWP systems for irrigation have been technically proven, are cheaper in long-run and have been available in market for years, they have yet to be adopted at scale in Nepal for irrigation and livestock purpose. In Nepal, solar water pumps are being mainly used for community drinking water supply purpose and these systems have been installed with high subsidy by government or grants form various development agencies. High subsidy for limited number of PVWP systems is limiting the growth of PVWP market.

Winrock International believes that if appropriate technology and business models can be made available, farmers will be able to purchase them from the additional income they earn from having reliable irrigation and water supply. Market development of PVWP requires establishing a supply chain, increasing level of awareness among farmers and making financing available to overcome high upfront costs.

## Objective

The PVWP project aims to increase awareness on the benefits of solar energy based water pumping system for irrigation, livestock watering and community water supply and to accelerate commercial sales of solar pumps to small holding farmers in Nepal thereby contributing to the productivity and self-reliance of the participating farmers and to the partial eradication of food deficit and improving livelihood among farmers' community in the country.

## Method

Winrock International is implementing the USAID funded "Accelerated Commercialization Solar Photovoltaic Water Pumping" (AC-PVWP) project in Nepal to address barriers through demonstration effects with innovative business and financing models to rural farmers which decreases the dependence on subsidy amount and instalment basis banking. The business models implemented in the project are direct purchase, financing through financing institution, lease- to- own, vendor financing, fee-for-service etc.

This project is implemented in close coordination with Alternative Energy Promotion Centre, a Government institution under Ministry of Population and Environment, which is responsible for developing and promoting renewable/alternative energy technologies in Nepal. This project, through installation of pilot PVWP systems in various parts of the country for demonstration purposes, is envisaged to create a replicable effect of acceptance of this technology by smallholdings farmers for irrigation purposes. The project major activity includes

- a. Raising awareness on PVWP technology  
The project is involved in raising awareness among famers supported by agricultural, Irrigation and livelihood projects and programs including USAID-funded Feed the Future (FtF) project KISAN, Food for Peace project SABAL, District Agriculture Development Office (DADO), and Nepal Agricultural Cooperatives Central Federation (NACCFL). These projects and programs have formed viable farmer groups and provide them with agricultural inputs like seeds, pesticides, tunnels, capacity development.
- b. Creating demonstration effect  
The project is providing technical, financial support and linkages to farmers for installation of PVWP system to create demonstration effect. Winrock International has supported PVWP systems installation in districts with high market potential.
- c. Supporting creation of scalable and profitable business models  
The project is working closely with PVWP supply companies to introduce new, affordable PVWP product range and develop new business and financing models for scaling up the PVWP market. SunFarmer and Gham Power have introduced rent-to-own business models where farmers get following offers:
  - Farmers have to pay 0-30% of the total system cost as down payment and can pay remaining 70 -100% on instalment basis over 3 years.
  - Free after sales service up to 3 years.
  - Handover option of PVWP system ownership to farmers after 3 years

d. Strengthening PVWP market system

The project facilitate linkage between PVWP supplier companies with agro-vets, promoted by KISAN project, agricultural cooperatives, and financing institutions to strengthen supply chain in rural areas. Agro-vets and small farmer cooperative are local service providers that provide agriculture and irrigation inputs and services to rural farmers. They see opportunities to make a reasonable profit by promoting PVWP system to their farmers because water is prerequisite for selling their agricultural inputs and services. Local banks and micro-finance institutions provide credit to farmers to enable them to purchase PVWPs.

### Business Model for Promotion of PVWP systems in Nepal

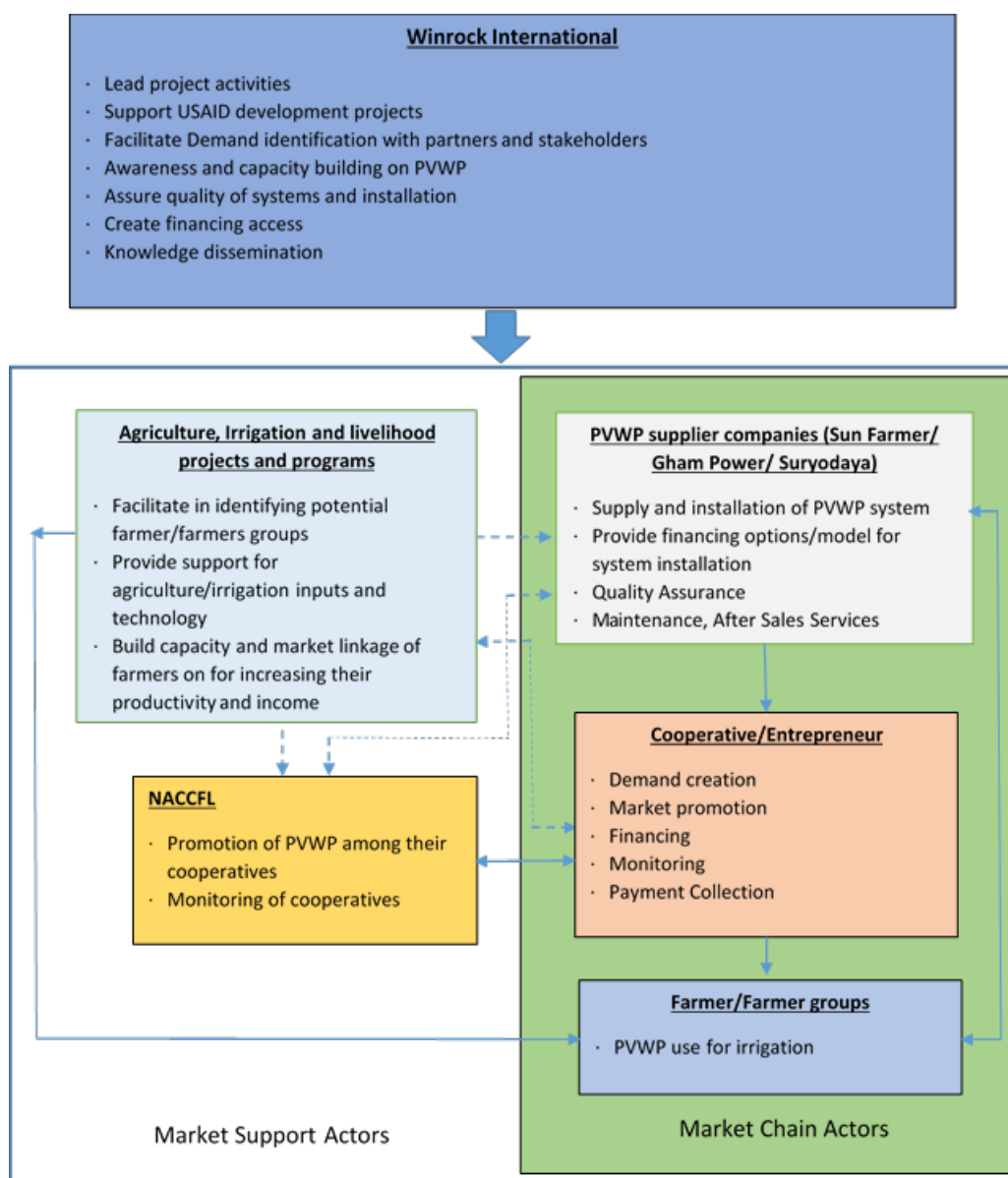

## Results

The Solar Water Pumping technology, supported by the government, various INGOs and External Development (ED) partners in Nepal, so far, is mainly covering water supply technology for drinking purposes. Through this project, for the first time in Nepal, the sustainable use of the same technology but for small scale irrigation purposes is demonstrated. It is envisaged that the success of this project will further support the government in policies formulation on eco-friendly and sustainable water pumping systems for small scale irrigation. To ensure farmers access to sustainable irrigation facility, under this project, Winrock International prioritized the requirement of water both for irrigation and livestock rearing activities.

There has been encouraging signs of impact of PVWP systems on various aspects of socio-economic indicators of a farmer livelihood, increase in irrigated land, more investment in farming and increased revenue as well as utilization of more labor forces are few to name. This access has created a positive change in the cropping pattern by allowing farmers to increase the number of crops being cultivated over the year, diversification to cash crops and vegetable farming, therefore shifting occupation of the beneficiary farmers from subsistence farming to enterprising/commercial farming. This has ultimately contributed to the productivity and self-reliance of the participating farmers.



Figure 1: Photovoltaic water pumping used for irrigation, livestock watering, fish farm and drinking water

In total this project has already installed 14 PVWP systems in various locations throughout the country. As a result of these promotional activities and interest small scale farmers, the demand for such type of systems is steadily growing.

Considering the scattered pattern of agriculture land in Nepal and difficulties and challenges in irrigating these plots, this PVWP technology can play a vital role in ensuring sustainable and effective access to water for irrigation by smallholdings farmers and therefore contributing to the partial eradicating of food deficit and improving livelihood among farmers' community in the country.



# **CHAPTER 5. EDUCATION FOR ENVIRONMENTAL SUSTAINABILITY AND RESILIENCE**

# Promoting the Greening Curriculum

*(A note on the Implementation of Environmental Education in Indonesian School)*

**Ikhfan Haris**

*Faculty of Education*

*State University of Gorontalo*

## **Abstract**

This paper presents Indonesia's experiences in implementing Environmental Education as a part of the national effort to establish environmental sustainability. The paper will discuss the emergence, the present status, and attempts to mainstream Environmental Education in the school curriculum in Indonesia. Finally, the challenges encountered in promoting and implementing Environmental Education in Indonesia will be highlighted.

## **Keywords**

*Environmental, Green, Curriculum, Education, School, Indonesia.*

## **1. Introduction**

Environmental Education in Indonesia formally started in 1975 at IKIP Jakarta as the pioneer of environmental education development. The institution formulated the Education and Teaching Program Outlines of Environmental Education (*Garis-garis Besar Pendidikan dan Pengajaran/GBPP*) and administered the trial at 15 elementary schools in Jakarta in the period of 1977/1978. In 1979, Environmental Study Center was established in different public and private universities. At the same time, AMDAL (Analysis on the Impact of Environment) education was developed at all Environmental Study Centers under the coordination of the Minister of Development and Environment Supervision (Soerjani, 2008).

The delivery of integrated demography and live environmental education at primary and secondary education levels (public and vocational) is outlined in the 1984 curriculum system by including demography and live environment issues into almost all subjects.

Environmental education development is also initiated by different non-government organizations. In 1996/1997, an Environmental Education Network of non-government organizations that were interested in environment education was established. There have been 76 members of the Network in 2001, working on developing and implementing environmental education.

## 2. The Objectives of Teaching and Learning of Environmental Education in Indonesia

Environment issues are caused by the inability to develop life style and social value system that are unable to be aligned with the environment. Developing attitude and life style that are aligned with the environment is not an easy task and cannot be done quickly (Singh and Gupta, 2013; Kollmuss and Agyeman, 2002; Dunlap and Jones, 2002).

Education is an appropriate means to build on the community that implements the principles of environment sustainability and ethics, starting from kindergarten until higher education. Therefore, the long-term objectives of live environment education are to create citizens who have the knowledge about biophysics environment and its related issues, to raise awareness to be effectively involved in the efforts to create better future development within the environment that is proper to live in, and to encourage motivation to make these happen (Stapp, et al., 1979.)

The objectives of environmental education are outlined at the Cross-Country Conference on Environmental Education in 1975 in Tbilisi, which are: increase awareness that relates with the mutual dependency in economy, social, politics, and ecology across cities and villages; provide everyone with opportunities to acquire knowledge, values, responsibility, and skills that are required to protect and improve the quality of environment; and create new attitudes of individuals, groups and society as a whole, leading towards a healthy, compatible, balanced environment. These objectives are classified into six groups as follows:

- a. Awareness – encouraging every individual to have awareness and sensitivity towards environment and its issues.
- b. Knowledge – helping every individual get a variety of basic experience and understanding of environment and its issues.
- c. Attitude – helping every individual get a set of attitudes and abilities to acquire proper choices, to develop sensitive feelings towards environment, and to motivate and actively participate in protecting and improving environment.
- d. Skill – helping every individual to get skills in identifying and solving environment issues.
- e. Participation - motivating every individual to actively participate in solving environment issues.
- f. Evaluation – encouraging every individual to acquire the ability to evaluate the knowledge of environment viewed from ecology, social, politics and education factors (Adisendjaja, 1988).

The elaborated objectives indicate that live environment issues mainly relate with human beings, not only the environment. Therefore developing environmental education program should focus on the attitudes of human beings, particularly their interaction with their live environment and ability to solve the environment issues (James & Stapp, 1974). Every theory in live environment education should cover both groups of knowledge.

In the context of Indonesia, environmental education became an essential component of the Indonesian environmental management strategy, therefore the Indonesian government has settled the objective of Indonesian environmental education, as follows: (1) to develop positive environmental attitudes among students; (2) to provide elementary knowledge, skills, and motivation to participate in the resolution, and anticipation of environmental

problems and (3) make indispensable for sustainable development and improved quality of life.

### 3. Teaching and Learning Strategy of Environmental Education at School

The Letter of Decree of the Minister of Education and Culture No. 008C/U/1975 stipulates that Demography and Environmental Education should start from Elementary Schools. It is stated in the Decree that Demography and Environmental Education is not taught as a standing alone subject but is integrated in certain subjects.

Environmental education is to develop new attitudes towards earth components of water, air, animals and plants that require a new, whole way of thinking that contradicts with a single, direct way of thinking (Wahyono, 2009). The objectives of environmental education at schools are as follows:

Helping young people understand the nature passionately and respecting other beings are determined by many factors, e.g. integral way of thinking by including environmental education into every subject. It is carried out by two methods:

1. Integrative approach - this approach is against the fact that the curriculum materials are already too much. In this approach, live environment education materials are integrated into relevant materials as outlined in the curriculum.
2. Monolithic approach – this approach is carried out separately or as a standing alone; therefore it is a whole unit approach, e.g. General Basic Subjects (*Mata Kuliah Dasar Umum/MKDU*) at universities.

It is expected that environmental education is actively taught by as many teachers as possible. This will enable the establishment of collaboration, internally at respective schools or externally between schools and related institutions and communities. External collaboration can be made with parents (to ensure that materials taught at schools are aligned with what is done at homes), partnered non-government organizations, the Department of Education and Culture, Local Government, and community. Environmental education is not limited to teaching and learning activities but is for the whole school activities. Various school activities can integrate environmental education, e.g. celebrate Earth Day (22<sup>nd</sup> April) and Live Environment Day (5<sup>th</sup> June) by planting trees; discuss current environment issues such as flood, jungle fire and pollution; conduct a field study of direct observation of the environment as the object; conduct classroom and school arrangement; conduct cleaning activities; be efficient in consuming natural resources.

One of the effective strategies in implementing environmental education in teaching and learning is contextual approach. The contextual approach is carried out by the following steps:

1. Develop a way of thinking that students will learn more meaningfully by working alone, finding by themselves, and constructing their own knowledge and skills.
2. Carry out inquiry-based activities (by cycles of observing, questioning, hypothesizing, collecting data, and making conclusion).
3. Develop students' curiosity by questioning.
4. Create learning community (learning in groups, small groups, peer groups, or hosted experts).

5. Model the examples of teaching and learning (teachers being the models in doing something such as seeding plants and recycling).
6. Reflect at the end of the class (such as direct statement on what is learned during the teaching and learning, notes or journals on the student notebook, comments and suggestions of students on the teaching and learning, discussion or evidence of student work).
7. Conduct authentic assessment such as assessing activities and reports, homework, quizzes, student works, journals, test results, and writings (Depdiknas, 2003).

The Ministry of Education (MoE), the apex body and the responsibility institution in the area of developing curriculum for the formal and non formal education system in Indonesia. However, until now there is a national debate going on about how to make EE not only widespread but also effective implement at all levels of education. The strategy under discussion envisages a three pronged approach. The three elements of the strategy are infusion, integration and as a separate subject.

Single-subject/separate subject approach, where components are drawn from a single academic discipline or treating it as a separate subject. Basically, this approach is more appropriate and suitable for higher/university education (Hendarti, 2012; Chelliah, 1985)

While, in the formal education curricula, environmental education can be implemented through those three strategies/approaches, infusion approach on EE education has been widely conducted by most of schools in Indonesia, although most teachers has difficulties to do this approach, due to lack of knowledge on environmental issues and lack of skill on methodology to apply this approach. According to Laksono (2008), there are some reasons for schools to prefer to conduct infusion approach for implementing EE, such as: (1) No need for additional teacher; (2) No competition from other standard competences; (3) No need for additional time for the lesson; (4) It can be applied although the curriculum has not been formalized yet and (5) It encourages learning transfer for teacher as well as it gives an opportunity for students to learn together for any grade

There has been special emphasis on the need to give importance to environmental education, and this has been kept in view while designing curricula, framing the syllabi and developing text books.

Environmental education can be taught by different ways such as observation, discussion, field practice, laboratory practice, practice report, seminar, debate, project work, internship, and adventurous work. The reminder is to provide not the lecturing of concepts that creates passive students as listeners but the learning environment that involves students actively in constructing knowledge, experience, and skills that can later be implemented in daily life and transferred to others. There are various places that can be used as the objects of learning: school environment, surrounding neighborhood, city area, market, stations, drainage system, river, paddy field, city park, airport, atom power generation, lake, drinking water processing installation, waste management, household waste pipe, waste dump, and other environment sites around school areas. Issues that can be raised as the teaching and learning topics are various, ranging from household waste; industrial waste; detergent use; pesticide; artificial fertilizer; aerosol and spray; land, water, air pollution; lack of water; flood, etc.

Implementing environmental education starts from environmental education curriculum and school internal policy that are based on environment-friendly life style. Practical concept

(action learning) and edutainment integrate education and playing elements as effective and efficient learning methods, which can help students learn from interesting things and start thinking to do positive things.

Environment education curriculum covers affective aspects of attitudes, values, and commitment that are required to help elementary students develop critical thinking to be part of environment-friendly community. These affective aspects are relatively difficult to be covered; therefore teachers should include applicative learning methods, e.g. practicing ways of changing waste into fertilizer.

Teachers need to point out that, in real life, individuals have different values when perceiving their environment. The differences can cause conflict of ideas. Therefore, live environment education needs to provide students with opportunities to develop skills that are required to solve live environment issues (Departemen Pendidikan dan Kebudayaan, 1999).

Theoretically, there are many factors which might be helpful to any design of EE curriculum and which may it easier to introduce, implement and establish the EE in the school. In order to meet the essential needs in delivering EE in the school, the government of Indonesia has enunciated the outlines of the content of environmental education consisting of Human and Environment; Natural Resources; Maintaining Hygiene & Environment; Water, Marine & Coastal; Air; Soil and Land; Energy; Forest; Ozon Depletion, Atmosphere & Global Warming. More detailed about this EE curriculum outline:

#### 4. Conclusion

Current environmental issues around the world cannot be merely solved by establishing a set of rules to manage human behaviors. The most important thing is how to set the behaviours. One of the efforts is by providing education from the very early age on the knowledge of environmental through schools (formal) or non-schools (non-formal). The way in which environmental education should be introduced to schools is one of the most difficult problems of its implementation in educational systems,

The impact of introducing environmental education to students of early age cannot be seen in a short-term but a long-term period. Investing in environmental education takes time and requires patience of different parties. Ongoing efforts to raise awareness and empower students and teachers on environment are strategic steps to ensure environment safety and development sustainability.

Even though environmental education has been implemented in Indonesia, the facts show that the country's damaged environment is getting worse, the natural resources are shortening, and the environment-friendly community is not fully established. Uncontrolled exploitation of natural resources is ongoing and is mostly done by educated individuals. These are caused by the followings:

- 1) Assessment on developing "*affective domain*" that is not yet part of assessment system for education results at schools.
- 2) Not all teachers around Indonesia are engaged.
- 3) Lack of education books on environmental education for teachers and students.

- 4) Lack of role models in the community on attitudes of sustaining relationship balance among human beings, between human beings and the chemical, physical, biological environments, and between human beings and their cultures.
- 5) Lack of communication between environment experts at universities and teachers at pre-university level.
- 6) Interest in EE need to be awakened, therefore effort to make the EE as interesting subject for the student is needed.

The complexity of environmental issues has made environmental education difficult to be implemented. Environmental issues and problems require knowledge and skill from a number of fields if they are to be understood properly and acted upon effectively, so no one discipline or specialty is sufficient to achieve this.

Finally, it should be acknowledged that environmental issues are systematic and complex and cover a wider scope. Therefore future challenges in implementing live environment education in Indonesia are on increasing commitment of all related stakeholders, acknowledging the importance of environmental education as an effort to maintain environment balance and life sustainability of human beings.

## References

- Adisendjaja, Y.H. (1988). *Hubungan antara Pemahaman IPA, Pengetahuan Lingkungan, dan Sikap terhadap Lingkungan dari Mahasiswa FPMIPA IKIP Bandung*. IKIP Bandung, Laporan Penelitian: tidak diterbitkan
- Chelliah, T. (1985). *Approach to Teaching Environmental Education in Schools*. Paper presented at Workshop on Consumers and the Environment for Secondary School Teachers. Kuala Lumpur. Malaysia.
- Danusaputro, St. M. (1981). *Environmental Education and Training*. Bandung: Binacipta Publishing Company.
- Departemen Pendidikan dan Kebudayaan. (1999). *Mengenal Lingkungan Hidup dari A sampai Z: modul keaksaraan fungsional*. Direktorat Pendidikan Masyarakat. Depdikbud
- Departemen Pendidikan Nasional. (2003). *Pendekatan Kontekstual*. Direktorat Pendidikan Lanjutan Pertama. Jakarta.
- Dunlap, R.E.; Jones, R.E. (2002). *Environmental Concern: Conceptual and Measurement Issues*. In Handbook of Environmental Sociology; Dunlap, R.E., Michelson, W., Eds.; Greenwood: Westport. CT. USA; pp. 482–524.
- Hendarti, Latipah. (2012). *Institutional Strengthening of Education for Sustainable Consumption (ESC). Advancing ESC Policy and Implementation Strategies Mapping opportunities in Indonesia*. United Nations Environment Programme (UNEP) and Yayasan Pembangunan Berkelanjutan (YPB). Jakarta.
- James, S. A. & Stapp, W.B. (1974). *Environmental Education*. New York: John Willey & Sons.

Kollmuss, A.; Agyeman, J. (2002). *Mind the Gap: Why Do People Act Environmentally and What are the Barriers to Pro-Environmental Behaviour?* Environment. Education Res., 8, 239–260

Lahiry, D., Sinha, S., Gill., J.S., Mallik,U., & Mishra, A.K. (1993). *Environmental Education. A Process for Pre-Service Teacher Training Curriculum Development*. NCERT. UNESCO — UNEP, JEEP, India.

Laksono, S. (2008). *Pengembangan Kurikulum Pembelajaran Konservasi, Lingkungan Hidup dan Mitigasi Bencana Alam: sebagai Upaya Pencegahan Kerusakan Lingkungan Hidup dan Bencana Ala Global*. Program Studi Pendidikan Biologi FKIP Universitas Sultan Ageng Tirtayasa, Serang, Banten.

Narendra Singh, Karnika Gupta. (2013). *Environmental attitude and Ecological Behaviour of Indian Consumers*. Social Responsibility Journal, Vol. 9 Issue: 1, pp.4 - 18

Soerjani, Mohamad. (2008). *Konsep Dasar Lingkungan Hidup Untuk Pengelolaan Ekosistem Bagi Kelangsungan Kehidupan: Buku Bacaan Masyarakat*. Institut Pendidikan dan Pengembangan Lingkungan didukung oleh Lembaga Penerbit Fakultas Ekonomi UI. Jakarta

Stapp, W., et al. (1979). *Toward A National Strategy For Environmental Education*. In A. Sacks and C. Davis (Eds.). Current issues V: The yearbook of environmental education and environmental studies (pp. 92-125). Columbus, OH: ERIC/SMEAC.

Sudjana, Nana. (2000). *Pengembangan kurikulum dan bahan ajar pendidikan lingkungan hidup secara terpadu dalam bidang studi PPKn, IPS, dan IPA di SD dan SLTP dalam rangka pembinaan sikap dan perilaku berwawasan lingkungan: evaluasi buku ajar : laporan hasil penelitian hibah bersaing VI/3 perguruan tinggi*. Fakultas Ilmu Pendidikan, Universitas Pendidikan Indonesia. Bandung

Tim Adiwiyata Tingkat Nasional. 2011. *Panduan Adiwiyata Sekolah Peduli dan Berbudaya Lingkungan*. Kerjasama Kementerian Lingkungan Hidup dengan Kementerian Pendidikan dan Kebudayaan. Jakarta

UNESCO. (2011). *Strategic Roadmap for Developing Green Schools Programme*. UNESCO Office. Jakarta.

Wahyono, Edy Hendras. (2009). *Modul pendidikan pelestarian alam dan lingkungan hidup: untuk guru sekolah menengah atas dan sederajat di Provinsi Aceh*. Fauna & Flora International-IP. Program Pendidikan dan Penyadartahuan Provinsi Aceh.



## Model Community for Zero Waste Management by 3Rs

Tubtim Limsoontorn

Environment Officer, Practitioner Level

Ratchaburi Provincial Offices of Natural Resources and Environment

e-mail: tubtim.siam@gmail.com

### **Keyword**

*waste management, 3Rs, climate change adaptation, organic waste, recycle waste, greenhouse gas emission reduction*

### **Background of the issue**

In 2014, Thailand had problem on the municipal solid waste (MSW) management because of accumulative MSW and improper disposal management. Then the government had put strong emphasis by approving the Roadmap of Solid waste management and Hazardous Waste. The Roadmap focuses on four principles 1) Eradicate cumulative MSW from the existing waste disposal sites 2) Design effective MSW and Hazardous Waste Management System that should be focused on reduces and recycle at source, centralized MSW management and explored waste to energy option 3) Update MSW and Hazardous Waste Management Regulations and Procedures and 4) Strengthen public awareness and incentive to cope with regulation

In fiscal year 2014-2016, Ministry of Natural Resources and Environment (MONRE) has focused on Climate Change Adaptation in term of Area-based Cooperation on Natural Resources and Environmental Management. So, 76 Provincial Offices of Natural Resources and Environment (PONRE) have had their own projects in difference area-based natural resources and environmental managements.

Ratchaburi PONRE recognized the important of municipal solid waste problem. Thus, we implemented the small scale project on “Model Community for Zero Waste Management base on 3Rs” in four communities. In fiscal year 2014-2015, the project was cooperated with the local governments - Kra Chub Sub-District Municipality (SDM), Wat Plang Sub-District Administration Office (SAO) and Ban Bueng SAO. This project consisted of series of activities, for example, study visit at the best practice center, Workshops on “Organic waste management by earthworm”, Assay writing and drawing contests to raise youth awareness on waste management by 3Rs.

Presently, we implement the project in 2 communities in Pho Tha Ram District, one is semi-urban community - Jed Sa Mian Sub-district, another is agricultural community - Tao Poon Sub-district. In this project, we work closely with Environmental Volunteer in both area to strengthen them in waste management and environmental volunteer network. The hypothesis of fiscal year 2016 is semi-urban community reduces more GHG emission than

agriculture community. For this paper was presented only the project that was done in fiscal year 2014.

## Objectives

- To disseminate knowledge on 3Rs waste management to communities
- To develop data collection on 3Rs waste management and analyze the GHG emission reduction

## Methods

### 1. Community selection :

Ratchaburi PONRE contacted the local governments and arranged the community selection. The criteria of community selection were 1) the potential local authorities and 2) the effective Environmental Volunteer network. Finally, we selected Don Kra Buang Ruamjai Phattana community, Kra Chub Sub-District Municipality (SDM) and Moo 5 community, Ban Bueng Sub-District Administration Office (SAO).

### 2. A series of activities :

#### 2.1 Study visit :

Ratchaburi PONRE set the study visit at Study Center for Deteriorated Land Restoration Method at Khao Cha Ngum of Royal Initiative Project in Ratchaburi. There were 35 participants form each community - 30 people from community and 5 local authority officers. The objectives of the study visit were 1) to get the idea and knowledge of waste management by 3Rs and 2) to apply the knowledge of waste management by 3Rs to their home and community. The Study center set learning demonstrations of EM producing, organic waste composting and earthworm cultivating.



Figure 1. Learning demonstrations

## 2.2 Workshops :

We set up the 3 workshop modules in 1) zero waste management by 3Rs 2) DIY from Recycle waste and 3) Organic waste management by earthworm. There were 55 participants in each module, 48 people from community and 5 local authority officers. The objectives of workshops were 1) the participants could apply idea and knowledge of waste management by 3Rs to waste management at their home and community 2) the participants could segregate, reduce and reuse waste at their households 3) the participants could apply organic waste to various utilizations 4) the participants had more income form zero waste management by 3Rs 5) the participants could disseminate the knowledge zero waste management by 3Rs to other people and other community.



*Figure 2. The workshop modules*

## 2.3 Youth Awareness Activity

To implement the Roadmap strategy, Ratchaburi PONRE concerned the youth awareness of good waste management practice. Then, we organized youth awareness activity by 3Rs waste management quiz, Assay Writing and Drawing Contest, and waste segregation quiz game at Thepin Pittaya School and Ban Phubornbon School site in Kra Chub SDM and Ban Bueng SAO, respectively. The objectives of this activity were 1) to promote the result of the project “Model Community for Zero Waste Management by 3Rs” 2) to raise youth awareness of good waste management practice and to build network of the community waste management by 3Rs and 3) to raise public awareness focusing the main parts of the community – people, school, and local government



*Figure 3. Youth Awareness Activity at Thepin Pittaya School*



*Figure 4. The winners of the quiz and contest at Thepin Pittaya School*

For Youth Awareness Activity, we invited 200 participants - 180 students from 6 schools, 20 teachers and local officers - to take part in this activity. The student participated in Assay Writing and Drawing Contest were 3 levels – Grade 1-3, Grade 4-6 and Grade 7-9. However, only the Grade 4-6 was invited for 3R waste management quiz.



Figure 5. Youth Awareness Activity at Ban Phubornbon School



Figure 6. The winners of the quiz and contest at Ban Phubornbon School

In the end of Youth Awareness Activity, Ratchaburi PONRE awarded the certificates and prizes to 70 students. However, we gave the small gift for student who jointed our waste segregation quiz game. All participants end up the activity with happiness and joyfulness.



Figure 7. Some of the winner drawings

### 3. Agricultural Equipment support

Ratchaburi PONRE supported 50 sets of agricultural equipment for Organic waste management by earthworm. 1 set was consisted of 0.5 kilogram of African Nightcrawler Earthworm, (3 plastic basins, 1 basket, 1 plow and 1 bag of dairy cattle manure). Moreover, we also supported 1 set of chopping wood machine for composting to both local government offices.



*Figure 8. Agricultural Equipment support*

### 4. Evaluation, Data Collection and Analyze:

We designed 2 times project evaluation for each community by visiting and advise how to raise earthworm to get high production. In the end of August, we collected the weights of the organic waste utilization – Organic Composting, EM producing and Earthworm feeding – and recycle waste selling from communities. Then, we input the data into greenhouse gas reduction calculation which was developed by Policy and Strategy Office and Thailand Greenhouse Gas Management Organization.

### 5. Leaflet and Pocketbook Publication :

Policy and Strategy Office – under the Office of the Permanent Secretary, MONRE – supported more budget for Publications of Waste Management by 3Rs Pocketbook (2,650 books) and Raising Earthworm Leaflet (5,000 leaflets).



Figure 9. Pocketbook: Publications of Waste Management by 3Rs



จากนั้นใช้กระดาษหรือตะแกรงพลาสติกกรองแยกตัวและมูลไส้เดือนออกจากกัน นำมูลไส้เดือนไปฝังในที่ร่ม ประมาณ 2 วัน หรือหากห้องในครัวเรือน สามารถถายนุ้คแยกไปใช้ได้เลย ส่วนตัวไส้เดือนนำไปเลี้ยงต่อได้

### การให้อาหาร

การให้อาหารทำได้โดยฝังเศษอาหารไว้ในวัสดุเลี้ยง ทั้งนี้สามารถให้เศษขยะอินทรีย์จากครัวเรือนได้ เช่น ข้าวสุก (ไม่มีไขมันและไม่มีเค็ม) เศษผัก เศษผลไม้ เช่น เปลือกมะละกอ กุ้งย่น้ำจืด เปลือกแตงโม แต่ไม่ควรให้พวกเน่าเหม็น ขมขื่น เนื่องจากมีความหวานมากจะทำให้เป็นตัวล่อคืบไม่มากเท่ากับไส้เดือนได้



### การใช้ประโยชน์จากมูลไส้เดือน

- สามารถใช้เป็นปุ๋ยสำหรับพืชผักได้ทุกชนิด
- ทำให้เกิดการหมุนเวียนของธาตุอาหาร
- ช่วยเพิ่มธาตุอาหารให้เกิดขึ้น นำลงดิน และปรับโครงสร้างของดิน
- ทำให้คุณภาพและสภาพของดินดีขึ้น นอกจากนี้ยังส่งผลให้พืชผักเจริญเติบโตได้ดีและมีรสชาติดีขึ้น
- เป็นการช่วยลดขยะอินทรีย์จากครัวเรือน
- เป็นการช่วยเพิ่มมูลค่าของขยะมูลฝอย



โครงการสร้างความร่วมมือด้านทรัพยากรธรรมชาติและสิ่งแวดล้อมในระดับพื้นที่ เพื่อรองรับการเปลี่ยนแปลงสภาพภูมิอากาศประจำปีงบประมาณ พ.ศ.2558 (จังหวัดราชบุรี)

สำนักงานทรัพยากรธรรมชาติและสิ่งแวดล้อมจังหวัดราชบุรี  
เลขที่ ๕๒ ถนนจอมพล ตำบลน้ำบ่อ  
อำเภอเมืองราชบุรี จังหวัดราชบุรี ๗๖๐๐๐  
โทรศัพท์ ๐ ๗๖๖ ๕๖๖๓ โทรสาร ๐ ๗๖๖ ๕๖๖๕

## การเลี้ยงไส้เดือนดิน เพื่อกำจัดขยะอินทรีย์



ส่วนสิ่งแวดล้อม สำนักงานทรัพยากรธรรมชาติและสิ่งแวดล้อมจังหวัดราชบุรี



ขยะอินทรีย์พวกเศษอาหาร เศษผัก ผลไม้เน่า เติมน้ำการ นำมาใช้ประโยชน์ในการทำปุ๋ยหมักหรือใช้ทำอาหารสัตว์อยู่แล้ว ซึ่งองค์ประกอบขยะมูลฝอยจากบ้านเรือน พบว่าขยะอินทรีย์มีสัดส่วนสูงที่สุด คือ ประมาณ ร้อยละ 50 ดังนั้น การกำจัดขยะอินทรีย์ด้วยไส้เดือนดิน จึงเป็นวิธีที่นำขยะอินทรีย์จากครัวเรือนมาใช้ประโยชน์

### วัตถุประสงค์

ปัจจุบันการเลี้ยงไส้เดือนดินเพื่อกำจัดขยะอินทรีย์ มีการเลี้ยงในภาคพื้นที่หลายหลาย เช่น องค์กรชุมชน ปศุสัตว์ การเลี้ยงในท้องตลาดก็ กิ่งนี้ขึ้นอยู่กับสภาพการบริหารจัดการ

ในเขตจังหวัดราชบุรี การเลี้ยงที่เป็นที่นิยม และนำต่อการบริหารจัดการ คือการเลี้ยงในกระเบื้องพลาสติกสีดำ โดยมีวัตถุประสงค์ ดังนี้

1. กระเบื้องพลาสติกสีดำ เบอร์ 55 (จะรู้ด้านข้างประมาณ 10-15 รู) 3 ใบ
2. มูลวัวนม ประมาณ 1 กระสอบปูน
3. ไส้เดือนสายพันธุ์ยูโรปรีกัน 0.5 กิโลกรัม
4. น้ำ
5. จอบหรือพั่ว
6. ตะแกรงหรือกระดาษพลาสติก

### การเตรียมวัสดุเลี้ยง (เบตง)

1. เตรียมมูลวัวนมสำหรับเลี้ยงไส้เดือน โดยต้องใส่ท้ายตอนในเบตงให้หมดไป ทำได้ 2-5 ลิ



ใช้ไม้และมูลวัวให้ฉีก ผึ่งแดดก่อนใส่ท้าย ใส่น้ำ ใช้น้ำจืดหรือฝนกรดก็ได้ (ถ้ามีน้ำขุ่น) ถ้ามีน้ำขุ่นใส่น้ำจืด 1 ลิตร หรือ น้ำยาล้างจาน 1 ช้อนโต๊ะ (ถ้ามีน้ำขุ่น) ใส่เกลือ 1 ช้อนโต๊ะ (ถ้ามีน้ำขุ่น) ใส่ปูนขาว 1 ช้อนโต๊ะ (ถ้ามีน้ำขุ่น) ใส่ปูนขาว 1 ช้อนโต๊ะ (ถ้ามีน้ำขุ่น)

2. นำมูลวัวที่ใส่ท้ายตอนในเบตงแล้ว ใส่น้ำกระฉ่ำ โดยให้มีความสูงประมาณครึ่งหนึ่ง (1/2) ของกระเบื้อง เพื่อระบายน้ำ



### วิธีการเลี้ยง

1. นำไส้เดือนสายพันธุ์ยูโรปรีกัน จำนวน 0.5 กิโลกรัม แบ่งเป็นสามส่วน ใส่น้ำกระฉ่ำ 3 ลิที่ใต้สี่เหลี่ยมที่ไว้แล้ว โดยชุดเบตงตรงกลางแล้วใส่ไส้เดือนแล้วคลุม



2. นำกระเบื้องไปวางในที่ร่ม และเปิดอากาศถ่ายเท



3. คอยดูแลความชื้นของวัสดุเลี้ยง โดยหมั่นคอยรดน้ำ 2-3 วันครั้ง ให้ความชื้นพอเหมาะ
4. ประมาณ 20 วัน ควรมีการพลิกกลับวัสดุเลี้ยง เพื่อให้ไส้เดือนย่อยสลายสารอินทรีย์ที่มีในมูลวัวนมอยู่อย่างทั่วถึง อาจใช้นิ้วพลิกกลับมูลวัว หรือคว่ำกระเบื้องใบที่มีวัสดุเลี้ยงคว่ำลงในกระเบื้องใบที่ว่าง
5. เมื่อเลี้ยงไปได้ ประมาณ 40-45 วัน ให้สังเกตดูความร่วนของมูลไส้เดือนว่าร่วนเสมอกันหมดกระเบื้องหรือไม่ ถ้ายังไม่ร่วนค่อยต่อไป ถ้าร่วนหมดแล้วให้หยุดให้น้ำ และรอให้มูลไส้เดือนค่อยข้างแห้ง ประมาณ 5-7 วัน



Figure 10. Leaflet: Raising Earthworm

**Results**

The result of overall project was successful. The model communities could manage solid waste by Organic composting, EM producing, animals and earthworm feeding approximately 1,755 kilograms and recycle waste selling around 6,685 kilograms. Thus, the reductions of GHG Emission were 1,973.15 and 7,067.25 kgCO<sub>2</sub> equivalent, respectively.

# **CHAPTER 6. ENERGY EFFICIENCY IN INDUSTRY, HOUSEHOLD, TRANSPORTATION AND BUILDINGS**

# Application of Mini Compressors to Recover Gas Flaring

Mohamad Fauzan Amir

\*\* Division of Project Management and Facilities Maintenance of SKK Migas (Special Task Force for Upstream Oil and Gas Business Activities Republic of Indonesia)

E-mail: mfamir@skkmigas.go.id

## ABSTRACT

From the environmental perspective and resource efficiency, gas flaring should always be minimized as much as possible, in line with safety considerations. Flaring could have detrimental impacts to the environment by producing emission, which could contribute to global warming. Gas that is flared may be resulted from a variety of sources, such as equipment changeover or maintenance shutdown. The waste associated to gas is due to a very low well pressures, which makes it unable to be distributed to the downstream facility.

Efforts are progressively being made to reduce gas-flaring depending on the cause of the flare. Low gas pressure waste could be minimized by applying a mini compressor, which serves as a gas booster. It would be able to suppress the released flares by compressing the suction gas to meet the downstream requirement. During the shutdown situation due to equipment changeover or maintenance, the flare could be avoided by temporarily replacing the existing equipment with a mobile compressor. By doing so, the plant would be able to be kept running during the maintenance phase.

This discussion highlights the technology applications in some oil and gas fields in Indonesia, as a case study of flare recovery. The solution has been proven to meet the expectations, not only resulting in the increased gas production worth millions of dollars, but also the proven ability to reduce CO<sub>2</sub> emissions released into the atmosphere.

Key words: flare recovery, mini compressor, production increase, CO<sub>2</sub> emission, Energy efficiency in industry

## 1. Introduction

The option to release gas to the atmosphere by flaring is a necessary practice in the upstream oil and gas industry. Flaring, which is a controlled burning of hydrocarbon gas streams, is necessary to prevent uncontrolled releases in emergency and shutdown situations, so that relieving dangerous condition of over-pressured equipment.

Although flaring is a common practice in the industry, the efforts to minimize the amount of gas flared have always been attempted by the companies generally for two reasons. First, there is a need to monetize as much value as possible from the hydrocarbons being produced. The second reason relates to the environmental issues. Flaring potentially could

produce emissions which has a significant impact to global warming, which should be the strongest reason as to why flaring should be minimized when possible.

Nevertheless, efforts are being made to reduce gas flaring depend on the flare causes. Sometimes, they could result from a combination of geographical condition, unavailability of customers, unfeasible gas reinjection project or even an extremely low pressure of waste gas to achieve the nearest processing station. Hence to many company, flaring is the most logical option. In another case, a production shutdown may also require the temporary flaring of all the gas stored on or arriving at a facility, to release high pressure and also to avoid a dangerous situation.

The essential point is that the efforts to dealing with associated gas will have to use creative and common sense approaches to address flaring concerns in specific operations. The current oil price drop may become the additional constraint in determining the feasibility of the flare recovery projects.

This paper describes a contribution of efforts in dealing with the gas flaring recovery in term of real application. Driven by flares from very low pressure of waste gas conditions and the production shutdown, some real applications are described and the results are shown. The solution is carried out by using mini compressors which offers a compact design, low-cost and removable once the associated gases are depleted.

## **2. Flare Reduction in Indonesia**

Currently, there are around 200 million cubic feet (MMSCFD) flare gas per day within various locations in Indonesia, with the volume ranging from 0.1 to 5 MMSCFD in each location [1]. The challenge is on how to utilize the flare gas existed in the remote area so it could benefit us. To reduce/eliminate flaring, suitable conditions are needed, including supportive institutions. Indonesian Government, in this respect Ministry of Energy and Mineral Resources of Republic Indonesia, has regulated the flare volume limitation and the obligation in flare utilization in term of production optimization [3]. Also, the target of gas flare reduction has been fixed to support the implementation of the flare regulation [8].

Although the regulation only applies in the recent years, efforts in dealing with flare reductions have actually been initiated long before the regulation was made. As reported by [2], some related projects had been done, such as the building of several utilization facilities for electric and steam generators, the building and re-running of LPG plants, re-injection to reservoirs, and export to Singapore and Malaysia. In addition, the usage of associated gas and reduction of gas flaring is promoted by expanding and establishing electric power generators and pipeline distribution, as well as by establishing good coordination between gas producers and consumers.

The efforts are still continuing until now. The significant drop in oil price is the current challenge. In this situation, the projects involving high capital investment are likely re-evaluated and usually are put on hold. Therefore, the oil and gas companies must be very selective to find low-cost ways in dealing with the flare reduction.

As the consequence of the production facilities spread across the country region, the next challenge comes from a large number of small flares distributed in the marginal fields and remote area. The efforts should be addressed on the low-cost investments and mobile technology that enable simple, compact and affordable installation. In addition to that, a

removable equipment whenever the reserve is depleted, as would be described in the fourth chapter.

### 3. Basic Process Description

Oil and gas produced from a well are rarely meets export quality. Normally, a well produces raw liquid which still containing oil, gas and water, as well as impurities that will need to be separated and treated further for export or disposal [4]. Figure 1 illustrates a basic diagram of the process and steps required.

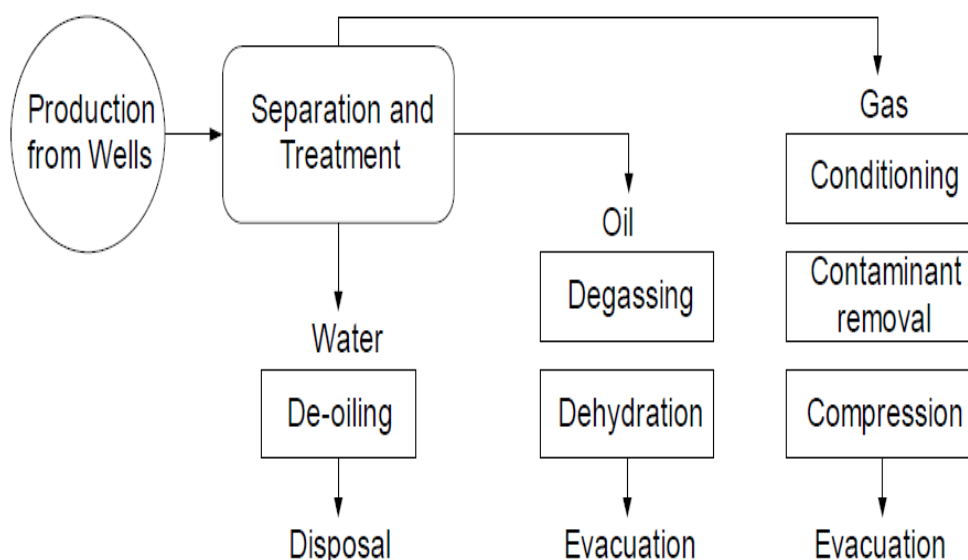

Figure 1. Basic Process Flow Schematic [4]

After being separated from oil, produced water still needs a de-oiling process to remove small amounts of the oil contained, so that it is safe to be disposed. Usually this de-oiling process uses settling or skimming tanks which works based on the gravity separation principle. To prepare any gas for evacuation, it is necessary to separate gas and liquid phases, as well as any unwanted component such as water vapour. In the case of associated gas, it can be sold or, when there is no gas market, its natural gas liquids can be extracted before the gas is flared or re-injected. The contaminant should be removed to avoid corrosion and toxicity, e.g. from hydrogen sulphide.

The evacuation process is originally driven by the natural pressure of the wells. Yet, as time goes by, the natural pressure starts to decline gradually, so that, for the well clusters far enough from the gathering stations, the oil and gas may be unable to reach the nearest processing facility or customers. Usually, to keep the oil production (instead of shutting the wells off), the oil pumps are then installed, while the gas lefts as flare. Such cases are quite commonly found in Indonesia.

Applying mini compressors may be able to suppress the released flare due to the very low gas pressure. By compressing the suction gas up to meet the downstream requirement, the gas can be boosted to achieve the next processing facility for being sold afterward.

In addition, for gas companies dominated by the small delivery compressors, shutdowns due to change over or the compressor maintenance will be affecting the flare release. With a lot number of the existing compressor population, accumulation of the compressor shutdowns clearly contributes to the large amount of the gas flare released to the environment. Hence, to overcome the situation, the flare can be avoided by temporarily replacing the existing equipment with a mobile compressor, which is removable in any location and anytime, by doing so the plant keeps running during the maintenance.

#### 4. Mini Compressor Technology

As introduced before, a mini compressor is used to boost gas with a very low pressure, below the specifications of the regular (standard) compressors. According to [5], this technology offers some advantages. First, the compressor is able to compress the gas and at the same time the engine take the fuel from the gas produced itself. Second, the compressor operates with the low suction pressure from 50 psig until vacuum condition (-6 psi) and discharge the gas pressure up to 400 Psig. Third, the size is relatively small with dimensions close to the size of a car (see Figure 2). With weigh less than 4 tons, the compressor is easily relocated at any time whenever needed.

The compressor works based on a single stage reciprocating technology with a small engine power of about 50 HP. Using a V8 engine design as shown in Figure 2 (left), it enables each side performing different functions. One side is used as engine, while the other one serves as compressor. Using natural gas as fuel taken from the suction pressure, the compressor adequately consumes a little fuel for the combustion need.

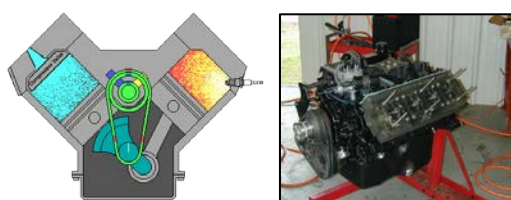

Source: GasJack Compressor [5]

Figure 2. Mini Compressor Engine

Figure 3 shows the main components of the mini compressor package, as they would be described in the following [6,7]. In general, it consists of 6 main parts, namely;

1. Control panel, is used to monitor and operate the operational parameters of the compressor and its engine.
2. Blow case, is a kind of scrubber used to separate gas and liquid. The separation process works based on the gravity principle, where the gas goes to the top side, while the liquid remains on the below one.
3. Engine compressor has a volume capacity of around 460 Cubic Inch, equipped by CDI electronic ignition module and protected by a manifold pressure safety shutdown. The

engine block is designed with multiple cylinders consisting of 4 cylinders generating power and 4 other ones related to a compression system. With the cycle  $\pm 2000$  rpm, the resulting noise is about 56.5 – 72 dB(A).

4. Exhaust, is used to release e exhaust gas emitted as a result of the combustion of the fuels. The exhaust gas still contains CO<sub>2</sub> and NO<sub>x</sub> less than 10 ton per annum.
5. Lube tank, is used as a 15 gallon lube oil storage tank for compressor engine
6. Cooler/Heat Exchanger, is used to reduce the gas temperature after compression, before sent to the sales line.

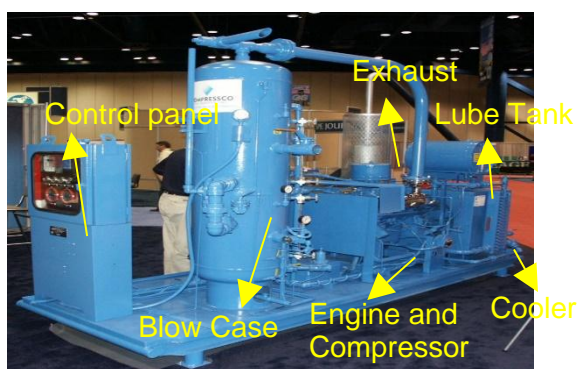

Source: GasJack Compressor Package [5]

Figure 3. Mini Compressor Package

Illustration of some applications in Indonesia is described in the following chapter.

## 5. Applications in Upstream Oil and Gas Industry

### Flare Recovery in Field S in West Java

This case study is taken from a gathering station producing oil and gas in a region in West Java in Indonesia. As represented by a simplified diagram in Figure 4, the LP separator receives crude liquid produced by some artificial lift wells, followed by the gas separation with a very low pressure. The associated gas is unable to compensate the back pressure from the customer trunk line; thus it is forced to be released in to atmosphere as flare. The gathering station usually releases flare in average 1.6 MMSCFD.



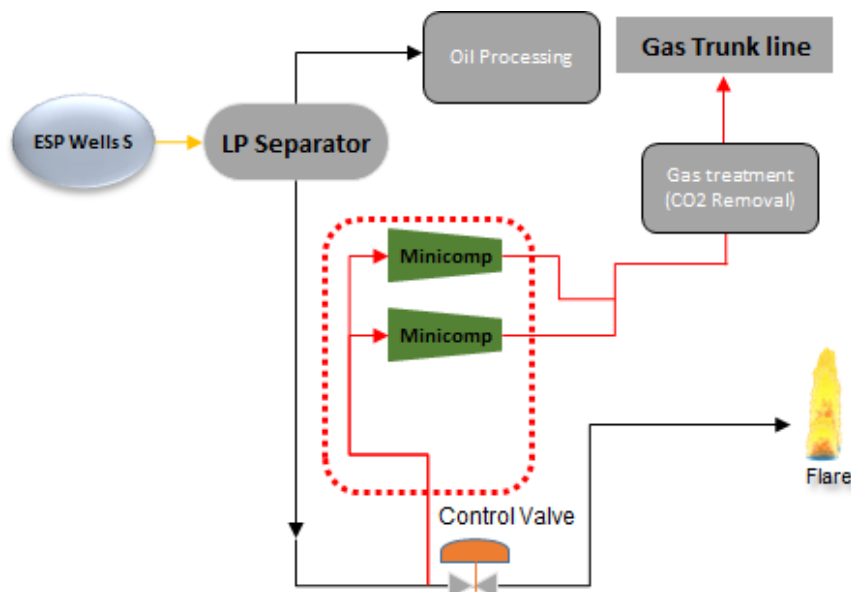

Figure 4. Simplified diagram of Mini Compressor installation in Field S

To minimize the flare, there are two alternative solutions. First, we can change the existing gas lift system into a close loop one that requires additional accessories and a rig rental. The advantage of using this technology is that all the associated gas can be re-injected into the wells, so the flare is no longer occurring. However, it gives a consequence of big capital investment, which tends to be avoided by top management. The second solution offers the use of a mini compressor placed around the well head that boost the very low pressurized gas to the desired point. Nevertheless, with the uncertainty of the depleted wells, the capital investment of a mini compressor may be not an accountable solution. A rental option within a certain duration with the low-cost is better in reducing the risk of the uselessness of the long-term capital investment.

The calculation for one-year duration estimates the recoverable gas volume about 237.7 MMSCF, or in average 0.65 MMSCFD after mini compressor installation.

The following figure displays a monitoring of the released flare before and after the compressor installation. Although the flare still remains, it is clearly seen that the flare reduction has been successfully achievable. Carbon emission calculated from the CO<sub>2</sub> proportion in the contained gas shows then that the CO<sub>2</sub> emission has been successfully decreased in average 1756 Ton CO<sub>2</sub>/Month.

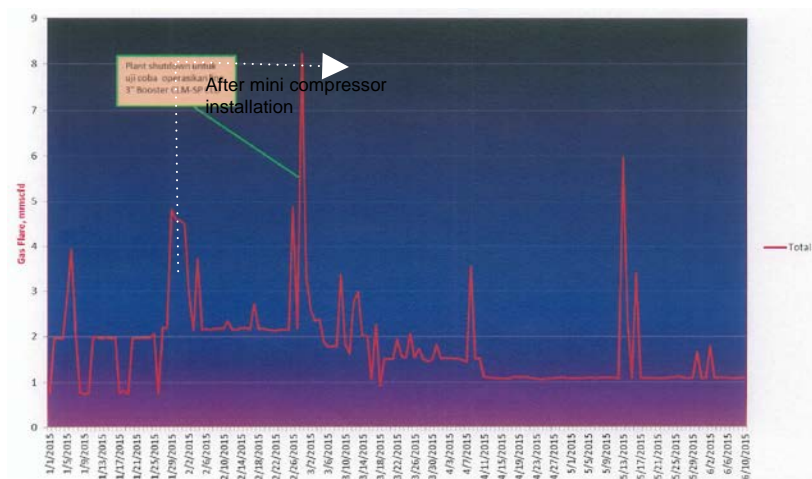

Figure 5. Flare monitoring in Field S before and after installation

### Flare Recovery in Field T in West Java

The same application also goes for an oil and gas field T in West Java. There is a potential flare about 4.3 MMSCFD from some well cluster that is recoverable. It comes from associated gas that is forced to be flared, due to the very low gas pressure to arrive the gathering station, while at the same time, the oil must remain in production (instead of the well shut in).

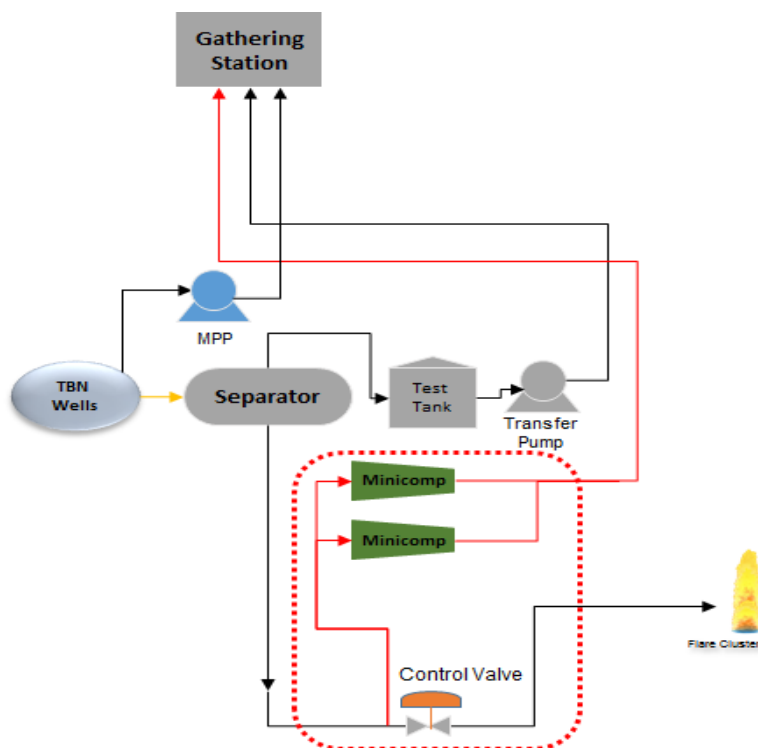

Figure 6. Simplified diagram of Field T (after mini compressor installation)

As shown in Figure 6, the use of the existing multi phases pumps (MPP) to transport the raw liquid (mix of oil, gas and its impurities) directly to the nearest processing facility is unreliable, because the gas void ratio (GVR) frequently hits the shutdown setting affected by the uncertainty of the subsurface factors.

The initiative to cope with this situation was then proposed by using mini compressors installed within the well cluster after the separation process (see Figure 6). Previously, the gas is separated from the crude oil and boosted by the compressor to the customer pipeline, while the remaining liquid (crude oil) is sent to the next processing facility by the transfer pumps.

It is obvious that the mini compressors contribute to the profit gain obtained from the gas flare recovery. This approach has reduced the gas flaring as monitored in Figure 7, with the recoverable about 1.92 MMSCFD or equivalent to one-year accumulation of 700.8 MMSCF. By calculating the CO<sub>2</sub> proportion contained in the recoverable gas, the CO<sub>2</sub> emission reduction achieves in average 2799 Ton/month.

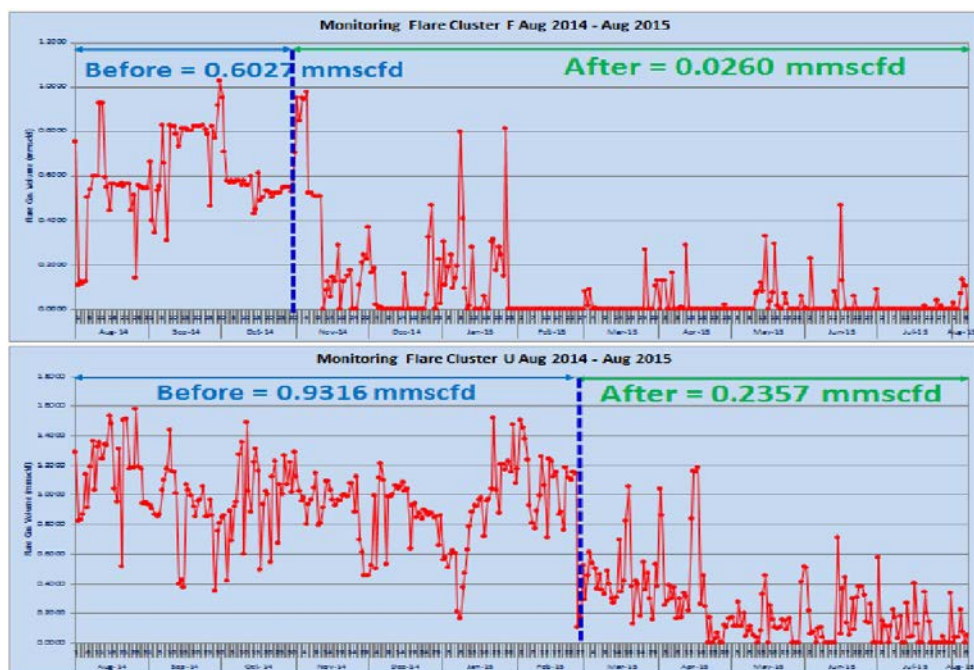

Figure 7. Flare monitoring in Field T before and after installation

### Flare Recovery in Field M in North Kalimantan

Based on the engineering study, the potency of 1.8 MMSCFD gas burned (as flare) at the two stations M5 and M12 can be still recovered to reduce the gas supply gap, which is still under the customer demand.

The associated gas is forced to be flared because its pressure is too low to achieve the gas pipeline heading to the gathering station. To deal with the back pressure, the modification is

necessary to be done by installing the mini compressors, as the improved design is shown in Figure 8.

The dash line in Figure 8 represents the simplified mini compressor package installed on the plant after modification. This application is proven to minimize flare, and obviously increase the gas production about in average 0.785 MMSFD or 286.5 MMSCF for one year. The increased gas production is presented in Figure 9, with the CO<sub>2</sub> emission reduction estimated about 1657 Ton/month.

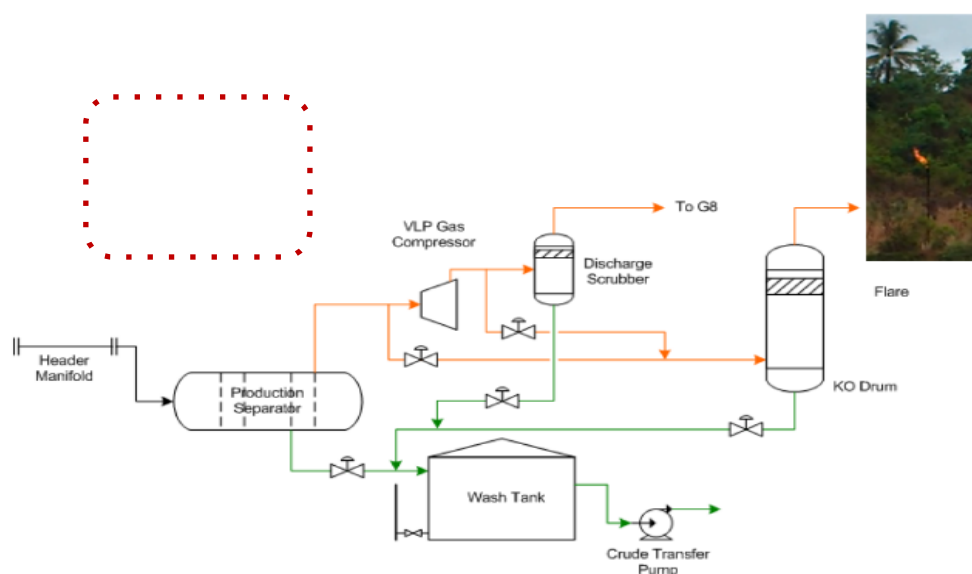

Figure 8. Improved design after mini compressor installation

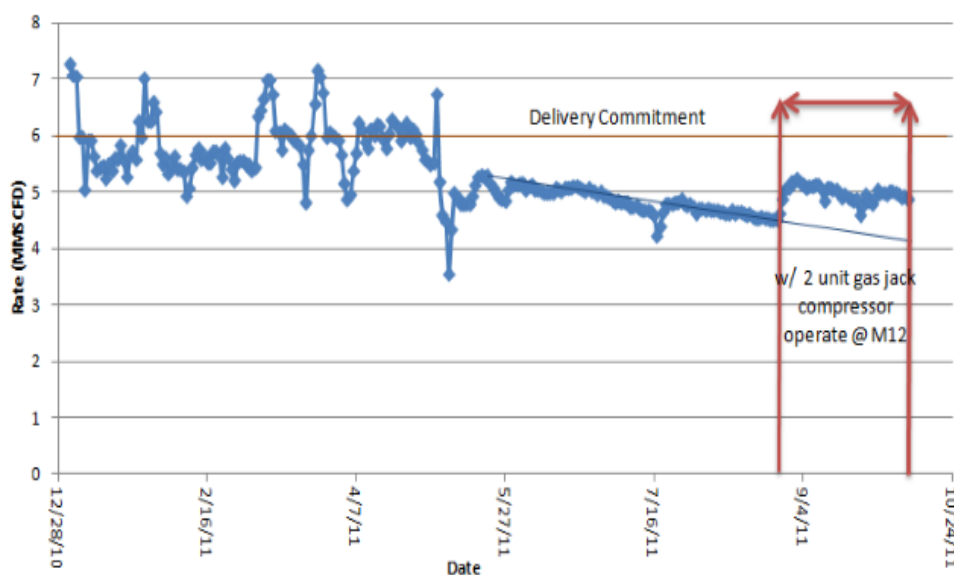

Figure 9. The increased gas production after mini compressor installation

### **Flare Recovery in Field J in Sumatera**

The application was installed in Field J in an oil and gas company in Sumatera. The aim of this project is to reduce the flare caused by the associated gas from an oil well pad. As reported by [7], due to the pressure decline, the natural flow of the associated gas is unable to achieve the gathering station, therefore it must be released as flare, to prevent the well shut-in.

To monetize the associated gas, a mini compressor was then installed. The suction pressure is compressed up to the higher value meeting the gathering station requirement. Concerning on the safety issue, of which the minimum flare is still needed, not all of the gas would be recovered. However, this recovery system successfully contributes the gas production increase about 0.176 MMSCFD or equal to 64.24 MMSCF for one year.

### **Flare Recovery in Field V in East Kalimantan**

In this case, wellhead compressors have been installed and playing a vital role in delivering the produced gas to the customers. To maintain the reliability of the compressor and its prime mover, the preventive maintenance is required. During the maintenance, shutting off the gas wells, if the ones are ageing and sensitive, is clearly not an expected option, because it likely causes the gas well depleted permanently. In other hand, flaring the gas is not an economical and environmental friendly solution. To cope with this situation, considering a lot number of the well head compressor population installed, the company operates some mobile compressors used to replace the existing compressors during their maintenance. This solution is proven to be feasible and able to reduce the gas flaring about 339.36 MMSCF recoverable for one year of use.

## **6. Conclusions**

This paper highlights some contributions resulting from mini compressor application to oil and gas fields in Indonesia. The technology is fit to recover flares caused by very low gas pressure, that is unable to achieve the customer lines. The solution is proven to meet the expectations, not only resulting in the increased gas production worth millions of dollars, but also to be able to reduce CO<sub>2</sub> emissions released into the atmosphere.

### **ACKNOWLEDGEMENT**

The author gratefully acknowledges the support of the management of SKK Migas and other parties (who, unfortunately, could not be mentioned one by one) in the realization of this paper. The author also thanks to DAAD for the accommodation support of attending this workshop.

## REFERENCE

- [1] Diskusi Panel Monetisasi Flare Gas Indonesia, available at: <http://www.skkmigas.go.id/en/skk-migas-selenggarakan-diskusi-panel-monetisasi-flare-gas-indonesia>
- [2] Gustya Indriani, "Gas Flaring Reduction in the Indonesian Oil and Gas Sector – Technical and Economic Potential of Clean Development Mechanism (CDM) projects" Hamburg Institute of International Economics, ISSN 0179-2253, 2005
- [3] Regulation of Ministry of Energy and Natural Resources Republic of Indonesia No. 31, 2012 (Peraturan Menteri Energi dan Sumber Daya Mineral Nomor 31 Tahun 2012)
- [4] Jahn, F., Cook, M., Graham, M.: Hydrocarbon Exploration and Production. Elsevier Science B.V. Amsterdam. 2001
- [5] "The Unique of GasJack Compressor: A Type of Very Low Pressure Compressor to Boost Well Production", Technology Corner, SPE Java, 2013
- [6] Achmad Nur Indrawan, Wahyu Ardi, Halifah, Sofiatul Mila; "Penggunaan VRU (Vapor Recovery Unit) untuk Mengurangi Emisi Gas Buang (Green House Effect) pada Lapangan S", Ikatan Ahli Teknik Perminyakan Indonesia Simposium Nasional dan Kongres X, 2008
- [7] Anugrah Victa Putra, "Studi Pemanfaatan Associated Gas pada Sumur SGC-X Menggunakan Gas Jack Compressor dalam upaya Zero Flaring Lapangan Sungai Gelam Pertamina EP" Final Project of Technical Faculty at Sriwijaya University, 2014.
- [8] President's Delivery Unit for Development Monitoring and Oversight (UKP4), "Toward Zero Flaring in Indonesia: Developing Policy on Gas Flare Reduction", GGFR Steering Committee Meeting, World Bank – Washington DC, 2011

## **“Detailing the Renewable Energy and Energy Efficiency Indicators fo Improving the Energy Security Model of Indonesia? A Preliminary Research”**

Erkata Yandri

E-Mail: erkata\_yandi2003@yahoo.com

Graduate Programe Renewable Energy, Darma Persada University, Jl. Radin Inten 2,  
Pondok Kelapa, East Jakarta 13450, Indonesia

*Keywords: energy security, renewable energy, energy efficiency, composite index*

### **BACKGROUND**

Energy is the key component to ensure the development of all countries, included Indonesia. Disruption of energy supply, both internally and externally, will directly affect the economic growth and development. To secure the national development, it is required an energy independence that leads to energy security. In general, energy security is defined as conditions that ensure the availability of energy, and public access to energy at affordable prices in the long term and, not affected by regional or international issues. The question now; how is the energy security condition in Indonesia?

Based on the latest data released by British Petroleum [1], since 1998, an increase of energy consumption, either oil, natural gas, coal, and electricity by 3.2%, 2.0%, 13.4%, and 7% year respectively. It should be noted that, in fact Indonesia is not a rich country in fossil energy reserves. The reserves of oil, natural gas, and coal have only 1%, 3%, and 3.6% of world reserves, respectively. Details, oil reserves consist of 3.7 billion barrels with production of about 332 million barrels/year, only enough for 12 years. Natural gas reserves of about 2.9 TCM (trillion cubic meters) and consume 0.07 TCM/year, then this is only sufficient for 41.6 years. In addition, the coal resources of 28 billion tones with a production of about 0.421 per year per year, then this is only enough for about 67 years.

In final energy consumption, industry sector is the biggest consumer, which is 38%, with a share of 40% coal, 23% oil, 28% of gas, and electricity by 9%. Followed by the transportation sector, which accounted for 35% of final energy consumption, which is almost 99, 65% depend to oil, the remaining electricity of 0.015%, and 0.03% of gas. The transportation sector is the highest growth rate consumption, 6.92% per year, driven by the automotive growth of 14.3% per year [2].

Among all the fossil energies, arguably, the most worried about is the oil. Imagine, fuel consumption is about 1.5 million barrels per day (BPD), which can be satisfied only approximately 0.8 million BPD as the average of lifting [1], and even then with the state owned refinery production is only about 0.6 million BPD [3]. That is, Indonesia has to import more than a half its consumption, of course, with world prices, which have a risk of price fluctuations. This condition will get worse if the tendency of personal transportation vehicles continue to increase (growing 14.3% per year [4]), as a result of poor public transportation

services. Inevitably, Indonesia must deal with global environmental issues (climate change mitigation, carbon trading, and the commitments to reduce emissions of 26% by 2020 [5]).

Meanwhile, almost 95% of the electrical energy source is currently generated by burning the fossil fuels, mostly coal and gas. Currently, the electrification ratio is about 80% (20% no electricity, especially in remote areas and outer islands). Electric energy demand growth rate is 7% per year, which is not matched by the supply growth, resulting frequent blackouts in several cities in outside Java. The government's target of 100% electrification ratio must be achieved by 2022, or 6 years from now. With an average increase of 1% per year, it seems that the target is difficult to achieve, if not with a mighty change [6].

Admittedly, the number of Indonesian population of about 248.8 million people, with the population growth of 1.49%, and the economic growth of 7% per year [3], have contributed to the increased of energy consumption [7]. However, it should be noted that the high dominance of fossil energy in the primary energy mix which is 97% compared with only 3% of renewable energy. The potential for renewable energy is huge, that is: micro-hydro 0.77 GW, geothermal 16,5 GW, biomass 0.18 GW, solar 4.8 kWh/m<sup>2</sup>/day, and wind 3-6 m/s [8].

Actually, in the year of 2006, the Government has issued the Presidential Decree No.05/2006, on a target of 17% energy mix from RE, with the details, as follows: 33% of coal, 30% of natural gas, 20% of oil, the remaining 17 % of renewable energy, which is; geothermal, hydro, solar, wind, biomass/biofuels, hopely energy investments amounted to USD 13.197 million [9]. As a reference, the status of primary energy consumption in 2006 [1], 24% of coal, 31% of natural gas, 43% of oil, and the remaining 2% of RE. Apparently, the realization of the primary consumption in 2013 is still far from the target, which is 32% of coal, 21% of natural gas, 44% of oil, and the remaining 2% renewable energy [1]. That is, after 7 years, no fundamental changes as a result of energy policies that have been issued previously.

Finally, in 2014, the government made revisions by issuing a new national energy policy, Presidential Decree No.29/2014, which corrects the target energy mix in 2025 and also in preparation for 2050, with details; 25% of coal, 22% for natural of gas, 24% of oil and 31% of new and RE [10]. The lessons learnt from the previous failures, the new current energy policy is an even bigger challenge for Indonesia.

Based on what has been discussed above, the general condition of Indonesia's energy as follows; high energy demand has not been matched due to lack of supply, distribution, and access; fossil energy reserves declined very rapidly due to consumption and export, there are still subsidized energy prices, which affect the poor energy conservation, utilization of RE is not optimal, unsupported by the capacity of R & D and energy industry, Indonesia should maintain the commitment on the issue of climate change.

In conclusion, Indonesia's energy security is quite vulnerable and weak [11] in facing energy trilemma [12]. Even though there have been several actions and programs based on energy policies and regulatory frameworks, include; diversification, substitution, technology development, and sustainability, which generally cooperate with friendly countries, companies and international organizations.

In fact, the discussion of energy security cannot be separated from the topic of energy models. Models are convenient tools in situations where performing tests or experiments in the real world are impractical, too expensive or out-rightly impossible. Energy security models, like other models, are simplified representations of real systems. They vary, ranging



from the simple to the complex or from the most important to the less important, depending on the type and number of indicators used.

In other words, the complexity of today's energy security issues, can no longer be anticipated with simple and common indicators, but might include the complex indicators, focus on the priority and objectivity as well. Ideally, designing energy security of a nation must be adapted to the specific context in a country, such as; special condition, level of economic development, risk perception, as well as the strength of the energy system and geopolitical issues [13]. That is, the opportunities for improvement to energy security is still wide open, because there is still a gap and freedom to a specific indicator [14].

## OBJECTIVES

The main purpose of this study is to improve the energy security models of Indonesia in order to get the accurate prediction for the spirit of the present and future through renewable energy (RE) and energy efficiency (EE). That is, from the fossil oriented to the development of RE and EE, with a focus on specific sectors (residential, commercial, industrial), and certain regional (rural and urban, Java or non-Java such as Sumatra, Borneo, Celebes, the Moluccas, Papua, etc.). In essence, how Indonesia improve the internal capabilities on energy supply by reducing dependence to the other countries. This is the real challenge and also opportunity. This model is expected to be used easily and widely by the policy makers for both at the central and local governments, or for the other related stakeholders especially in Indonesia.

## METHODS AND ANALYSIS

**Review:** In this preliminary study, we have done some review papers related to the energy security. Energy security is a fairly active area of research in recent years, discussed range from concept of definition, framework methodology to determine the dimensions, the indicators used by certain techniques (surveys, interviews, ec), and the development of the composite index, as well as assessment evaluation for comparison by single or grouped countries. It can be seen from various review papers, such as the discussion of “typology of energy and security” [15], “definition, dimension, and indexes” [14], “perspective to integrate the disciplines root of politics, science and engineering, and economics” [16], and “commonly used methodology and approach” [17][18]. Due to ambiguous and allows for multiple interpretations, the existence of highly multidisciplinary topics within energy security, it is suggested to be categorized into four perspectives: geopolitical, economic, policy related, and technological, with diversification strategy is very important for ensuring energy security over the entire supply process [19].

So far, there is no clear and unequivocal agreement on the definition of energy security, but shortly, IEA defined that energy security as “the uninterrupted availability of energy sources at an affordable price” [20]. Previously, the concept of energy security of a country is to secure access to fossil energy sources, such as oil [21]. Then, to answer the challenging complex energy security, the increasing need for energy while depleting reserves of world oil, and increasing pressure on global climate change, the issues extend to such as; price volatility, supply chain, political stability of oil-producing region, environmental sustainability, renewable energy, energy efficiency, and so on, various models have been offered by applying certain methods and techniques involving various indicators, simplified into a composite index. A dynamic model based on Bayesian method for energy security

assessment was proposed to forecast the values of indicators, using four different approaches: algebraic, ordinary least square, pairwise correlations and the Bayesian method. The method involved the expert judgment as preliminary information (with uncertainties) [22], then tried to assess the Ukrainian's energy security [23].

A study of the applicability of various methods, from more than 90 published papers, summarized that the Multi-Criteria Decision Making (MCDM) techniques are gaining popularity in sustainable energy management which can provide solutions to the problems involving conflicting and multiple objectives [24][25]. Through the quality function deployment (QFD), the experts are guided toward identifying key energy security components, including indicators and policies, and in making these components consistent, focused, and customized for a particular country, to construct a customized set of key factors for new models [26]. To show the level of energy security, a point system assessment scale is used to integrate the characteristics of the indicators [23]. By considering 25 individual indicators representing social, economy and environmental dimensions, AESPI (Aggregated Energy Security Performance Indicator) has been developed which required the detailed time series data for methodology development. With value 0-10, AESPI can evaluate past and future performances trend, improve the overall energy security performance and benchmark for further improvement [27].

Sovacool, researcher from Aarhus University, focused on 5 dimensions such as; availability, affordability, efficiency, sustainability, and governance, produced some comprehensive papers, such as; evaluating energy security in the Asia Pacific with a more comprehensive approach [28] based on previous work by Vivoda [18], an international survey to explore propositions about perceptions of energy security [29], propose the creation of an Energy Security Index to inform policymakers, investors and analysts about the status of energy conditions [30], synthesize the workable framework for analyzing national energy security policies and performance [31], present an energy security index which measures national performance on energy security over time. Based on three years of research involving interviews, surveys, and an international workshop, this study conceptualizes energy security as consisting of the interconnected factors of availability, affordability, efficiency, sustainability, and governance. matches these factors with 20 metrics comprising an energy security index, measuring international performance across 18 countries from 1990 to 2010 [32], and explains why an energy security index is needed, then justifies research interviews as a data collection tool [33] to respond the critiques [34]. Then, his quantitatively methodology was followed to assess the energy security for Malaysia and other ASEAN countries [35].

In 2008, there were already initiated to create an unofficial forum to discuss energy security for countries around Asia Pacific, including Indonesia, called; Asia Pacific Regional Energy Security (pares), initiated by the Nautilus Institute, USA. As described in both papers [36][37], the forum examines such dimensions; energy supply, economic, technological, environmental, social ad cultural, military/security. Unfortunately, so far there has been no official publication of the results that have been achieved, particularly on Indonesia's energy security. Due to lack of coherence as performance in one dimension is not necessarily relevant to the other performances from recent studies, an integrated simulation approach uses system dynamics as a modeling tool, was proposed to identify and establish the relationships between those components. Simulation showed that the individual analysis of the dimensions' performances shows the policies designed to improve Indonesia's energy security may conflict with each other [38]. Based on the assessment of energy security from

1990 to 2010 with a focus on five dimensions, such as; availability, affordability, technology development, efficiency, environmental sustainability, regulation and governance [31], shows that the increase in energy sustainability Indonesia less than 0.1%, lower than the achievement of other ASEAN countries such as Malaysia, Brunei, Vietnam, and Singapore [39].

**Analysis:** To answer the question in the title of this paper, there are some questions and concerns needed to be discussed here:

*Why is the energy security of this model focused more to RE and EE?* If the paradigm of high dependence on fossil energy has not shifted, both for consumption and export, so do not expect many RE and EE activities will receive serious attentions in Indonesia. As a result, the poor development of RE by the reason of limited investment and research, EE has not been entrenched nationally. To increase both production and proven reserves are a necessity, but to reduce the percentage contribution of fossil energy in the national energy mix is also a top priority for Indonesia. In addition, the contribution of RE in the national energy mix should be encouraged [40]. Hopefully, the model will further accelerate the RE and EE development in Indonesia, ofcourse with the transition from oil [41] to coal, or natural gas [42]. RE and EE are the twin pillars and the foundation of a sustainable energy policy, which can play an important role in mitigating energy security risks and emission issues.

*How important is the renewable energy policy for the development of Indonesia?* The deployment of RE policy is very important for the development of Indonesia. At least, there are two real contributions from RE projects. First, to increase the diversity of energy sources such as electricity, through local generation, contributes to the security, flexibility and resilience of energy systems. Second, increasing the income per capita as increasing the RE consumption per capita. Across time, RE consumption percapita in emerging economies is expected to grow faster than real percapita income [43]. Both contributions only can be achieved by designing an effective RE policy with a good understanding of energy system and RE income characteristic.

*How important is the energy efficiency policy for the development of Indonesia?* The deployment of EE policy is also very important for the development of Indonesia. At least, there are two real contributions from EE programs. First, the improving EE policy is relatively preferable to limit the energy consumption policy, which increases the income of the majority of households, without worrying "rebound effect", or increasing energy used [44], such as the case of India [45]. Second, the facts, implementation EE energy-saving technologies programs in developing countries, has shown quite favorable investment [46]. Actually, some EE policies have been implemented in Indonesia since 2006, but the results are very small. As one of the highest energy intensity country in the world, also the EE policy has not harmed the economic growth, Indonesia should re-introduce the EE policy [47].

*What indicators should be used, especially for the accuracy toward 2015 and 2050?* Energy security is difficult to measure using too simple or too complex indicators. Actually, from what we have discussed previously, Indonesia's energy policy has to focus primarily on the simple availability dimension (reflects to Presidential decree No.5/2006 and 30/2007), which the self-sufficiency and the diversification of fossil energy are the main priorities. Indonesia should be more focus to the other dimensions, such as; affordability (energy prices & subsidy), efficiency, acceptability, socio-effect, environment, governance, and so on. (Note: The indicator of RE is normally inclusively in the dimension of availability).

*How to interpret the indicators, into a dimension that is easier to understand?* To accelerate the understanding of those indicators, they need to be converted into a single index, called the composite index (CI). CI is formed on the basis of an underlying model of the multi-dimensional concept that is being measured. Technically, CI is a mathematical aggregation of a set of sub-indicators for measuring multi-dimension concepts that cannot be captured by a single indicator [48]. When the number of indicators used is small, the energy security index is generally very sensitive to changes in any of the indicators. Changes in the indicators will affect the other indicators, which ultimately affects the stability index. Conversely, when the number of indicators use is dislarge, changes in individual indicators may be muted out by the majority of unchanging indicator. That means, the more widely accepted practice seems to use the presentative set of indicators that can produce a broad overview of the energy security situation.

*How to make a more detailed the indicator of RE and EE?* According to the title of this proposal, generally for RE and EE, both are made in more detail with the notation based, such as; Sector (residential = R, commercial = C, industrial = I, and Regional (Java = J, out of Java = OJ, splitted to the island of Sumatra (OJS), Borneo (OJB), Celebes (OJC), Moluccas (OJM), Papua (OJP), and so on. Then, specifically for RE, it can be subdivided into: non-Solar (NS) and Solar (S), which can splitted to thermal (T), electricity (E), and so on. So, the indicator that describes RE in the residential sector has the notation of RRE, or more details for solar thermal in Sumatera island (out of Java) has the notation OJSTRE. Likewise RE notation is also applied to EE, which can be detailed as; Main (cooling = C, heating = H) and Support (lighting = L, others = O).

*Now the question is, can the energy security model provoke the industrialization of RE and EE in Indonesia?* Yes, ofcourse, by controlling the right priority and accuracy, the energy security model has the advantage to provoke the industrialization of RE and EE in Indonesia. The effects can be seen from the activities of the intensification and diversification energy supply, technology development, additionally more jobs will be created [49][50]. Those activities will support the economic growth by stimulating the development of national industry based on RE and EE. The results only can be achieved with a greater uptake of more efficient energy technologies to reduce energy demand, and further adding the portion of RE into the national energy portfolio.

## **RESULTS and CONCLUSIONS**

Based on the method and analysis above, the results can be summarized as follows:

- The existing models merely the result of calculation, tend to be as predictive analysis without giving an overview and detailed solutions about what to do, especially for specify country.
- From the scientific papers that discuss related to Indonesia, both regional and national, none of which specifically provides more detailed analysis of RE and EE. As a developing and archipelago country, which is divided into several regions and many rural areas in the borders do not have good access to energy, so the development of an energy security like Indonesia needs to be modeled differently [51].
- Since several methodologies are usually used separately, which depart from conflicting assumptions and promote opposing solutions, the option is to combine

theses methodologies for bridging the gap between of various assumptions and scientific fields for simultaneously improving current valuations [17].

- The model should be used as accurate long-term planning, as well as tracking, and following up (actual vs. projected), at anytime and anywhere using the advances of telecommunications technology today. So, for ease and speed of decision-making, it should be considered to visualize the energy security model into the dashboard system, included the composite index.

As conclusion, to increase the security level, the "dynamic and adaptive models with generic methodology" to develop the proper model with the right dimensions and detail indicators for RE and EE [22] and "multi-energy system" to open the implementation opportunity of RE and EE technologies for an archipelagic country multi sectors like Indonesia [52][53], should be considered appropriately.

## REFERENCES

- [1] British Petroleum, "BP Statistical Review of World Energy 2015," 2015.
- [2] BPPT, "Outlook Energi Indonesia 2014," 2014.
- [3] Badan Pusat Statistik, "Statistical Yearbook of Indonesia," Jakarta, 2014.
- [4] A. of I. A. Industries, "Indonesia Auto Market By Category 2015," 2015.
- [5] UNFCCC, "Appendix 2C - An overview of pledges and current greenhouse gas emissions by country," pp. 1–7, 2013.
- [6] PLN, "Statistik PLN," 2013.
- [7] M. Shahbaz, Q. M. A. Hye, A. K. Tiwari, and N. C. Leitão, "Economic growth, energy consumption, financial development, international trade & CO2 emissions in Indonesia," *Renew. Sustain. Energy Rev.*, vol. 25, pp. 109–121, 2013.
- [8] Pusdatin ESDM, "Handbook of Energy & Economic Statistics of Indonesia 2014," 2014.
- [9] P. R. of Indonesia, *Peraturan Presiden Republik Indonesia No.5 Tahun 2006*. Ministry of Energy & Mineral Resources, 2006.
- [10] P. R. of Indonesia, *Peraturan Presiden Republik Indonesia No 79 Tahun 2014*. Ministry of Energy & Mineral Resources, 2014.
- [11] S. Mujiyanto and G. Tiess, "Secure energy supply in 2025: Indonesia's need for an energy policy strategy," *Energy Policy*, vol. 61, no. 5, pp. 31–41, 2013.
- [12] N. Gunningham, "Managing the energy trilemma: The case of Indonesia," *Energy Policy*, vol. 54, pp. 184–193, 2013.
- [13] L. Chester, "Conceptualising energy security and making explicit its polysemic nature," *Energy Policy*, vol. 38, no. 2, pp. 887–895, 2010.
- [14] B. W. Ang, W. L. Choong, and T. S. Ng, "Energy security: Definitions, dimensions and indexes," *Renew. Sustain. Energy Rev.*, vol. 42, pp. 1077–1093, 2015.
- [15] B. Johansson, "A broadened typology on energy and security," *Energy*, vol. 53, pp. 199–205, 2013.
- [16] A. Cherp and J. Jewell, "The three perspectives on energy security: Intellectual history, disciplinary roots and the potential for integration," *Curr. Opin. Environ. Sustain.*, vol. 3, no. 4, pp. 202–212, 2011.
- [17] A. Månsson, B. Johansson, and L. J. Nilsson, "Assessing energy security: An overview of commonly used methodologies," *Energy*, vol. 73, pp. 1–14, 2014.
- [18] V. Vivoda, "Evaluating energy security in the Asia-Pacific region: A novel methodological approach," *Energy Policy*, vol. 38, no. 9, pp. 5258–5263, 2010.
- [19] E. Kiriya and Y. Kajikawa, "A multilayered analysis of energy security research and the energy supply process," *Appl. Energy*, vol. 123, pp. 415–423, 2014.

- [20] I. E. Agency, "What is energy security?" [Online]. Available: <http://www.iea.org/topics/energysecurity/subtopics/whatisenergysecurity/>. [Accessed: 20-Aug-2015].
- [21] J. Bielecki, "Energy security: Is the wolf at the door?," *Q. Rev. Econ. Financ.*, vol. 42, no. 2, pp. 235–250, 2002.
- [22] J. Augutis, R. Krikštolaitis, S. Pečiulytė, and I. Žutautaitė, "Dynamic model based on Bayesian method for energy security assessment," *Energy Convers. Manag.*, vol. 101, pp. 66–72, 2015.
- [23] J. Augutis, R. Krikštolaitis, L. Martisauskas, and S. Pečiulyte, "Energy security level assessment technology," *Appl. Energy*, vol. 97, pp. 143–149, 2012.
- [24] S. D. Pohekar and M. Ramachandran, "Application of multi-criteria decision making to sustainable energy planning - A review," *Renew. Sustain. Energy Rev.*, vol. 8, no. 4, pp. 365–381, 2004.
- [25] J. J. Wang, Y. Y. Jing, C. F. Zhang, and J. H. Zhao, "Review on multi-criteria decision analysis aid in sustainable energy decision-making," *Renew. Sustain. Energy Rev.*, vol. 13, no. 9, pp. 2263–2278, 2009.
- [26] J. Shin, W.-S. Shin, and C. Lee, "An energy security management model using quality function deployment and system dynamics," *Energy Policy*, vol. 54, pp. 72–86, 2013.
- [27] J. Martchamadol and S. Kumar, "An aggregated energy security performance indicator," *Appl. Energy*, vol. 103, pp. 653–670, 2013.
- [28] B. K. Sovacool, "Evaluating energy security in the Asia pacific: Towards a more comprehensive approach," *Energy Policy*, vol. 39, no. 11, pp. 7472–7479, 2011.
- [29] B. K. Sovacool, S. V. Valentine, M. Jain Bambawale, M. a. Brown, T. de Fátima Cardoso, S. Nurbek, G. Suleimenova, J. Li, Y. Xu, A. Jain, a. F. Alhajji, and A. Zubiri, "Exploring propositions about perceptions of energy security: An international survey," *Environ. Sci. Policy*, vol. 16, pp. 44–64, 2012.
- [30] B. K. Sovacool and M. A. Brown, "Competing Dimensions of Energy Security : An International Perspective," 2009.
- [31] B. K. Sovacool and I. Mukherjee, "Conceptualizing and measuring energy security: A synthesized approach," *Energy*, vol. 36, no. 8, pp. 5343–5355, 2011.
- [32] B. K. Sovacool, "An international assessment of energy security performance," *Ecol. Econ.*, vol. 88, pp. 148–158, 2013.
- [33] B. K. Sovacool, "The methodological challenges of creating a comprehensive energy security index," *Energy Policy*, vol. 48, pp. 835–840, 2012.
- [34] A. Cherp, "Defining energy security takes more than asking around," *Energy Policy*, vol. 48, pp. 841–842, 2012.
- [35] S. Sharifuddin, "Methodology for quantitatively assessing the energy security of malaysia and other southeast asian countries," *Energy Policy*, vol. 65, pp. 574–582, 2014.
- [36] D. Von Hippel, T. Savage, and P. Hayes, "Introduction to the Asian Energy Security project: Project organization and methodologies," *Energy Policy*, vol. 39, no. 11, pp. 6712–6718, 2011.
- [37] D. Von Hippel, T. Suzuki, J. H. Williams, T. Savage, and P. Hayes, "Energy security and sustainability in Northeast Asia," *Energy Policy*, vol. 39, no. 11, pp. 6719–6730, 2011.
- [38] Y. Prambudia and M. Nakano, "Integrated simulation model for energy security evaluation," *Energies*, vol. 5, no. 12, pp. 5086–5110, 2012.
- [39] B. K. Sovacool, I. Mukherjee, I. M. Drupady, and A. L. D'Agostino, "Evaluating energy security performance from 1990 to 2010 for eighteen countries," *Energy*, vol. 36, no. 10, pp. 5846–5853, 2011.
- [40] I. E. Agency, "Contribution of Renewables to Energy Security," no. April, 2007.
- [41] N. Lefèvre, "Measuring the energy security implications of fossil fuel resource concentration," *Energy Policy*, vol. 38, no. 4, pp. 1635–1644, 2010.
- [42] R. F. Aguilera and R. D. Ripple, "Modeling primary energy substitution in the Asia Pacific," *Appl. Energy*, vol. 111, pp. 219–224, 2013.
- [43] P. Sadorsky, "Renewable energy consumption and income in emerging economies," *Energy Policy*, vol. 37, no. 10, pp. 4021–4028, 2009.

- [44] D. Hartono and B. P. Resosudarmo, "The economy-wide impact of controlling energy consumption in Indonesia: An analysis using a Social Accounting Matrix framework," *Energy Policy*, vol. 36, no. 4, pp. 1404–1419, 2008.
- [45] J. Roy, "The rebound effect: Some empirical evidence from India," *Energy Policy*, vol. 28, no. 6–7, pp. 433–438, 2000.
- [46] L. Alcorta, M. Bazilian, G. Simone, and A. Pedersen, "Return on investment from industrial energy efficiency: evidence from developing countries," *Energy Effic.*, vol. 7, no. 1, pp. 43–53, 2013.
- [47] E. Yıldırım, D. Sukruoglu, and A. Aslan, "Energy consumption and economic growth in the next 11 countries: The bootstrapped autoregressive metric causality approach," *Energy Econ.*, vol. 44, pp. 14–21, 2014.
- [48] P. Z. Æ. B. W. A. Æ. D. Q. Zhou, "Weighting and Aggregation in Composite Indicator Construction : a Multiplicative Optimization Approach," pp. 169–181, 2010.
- [49] U. Lehr, C. Lutz, and D. Edler, "Green jobs? Economic impacts of renewable energy in Germany," *Energy Policy*, vol. 47, pp. 358–364, 2012.
- [50] M. Wei, S. Patadia, and D. M. Kammen, "Putting renewables and energy efficiency to work: How many jobs can the clean energy industry generate in the US?," *Energy Policy*, vol. 38, no. 2, pp. 919–931, 2010.
- [51] F. Urban, R. M. J. Benders, and H. C. Moll, "Modelling energy systems for developing countries," *Energy Policy*, vol. 35, no. 6, pp. 3473–3482, 2007.
- [52] P. Mancarella, "MES (multi-energy systems): An overview of concepts & evaluation models," *Energy*, vol. 65, pp. 1–17, 2014.
- [53] H. Ren and W. Gao, "A MILP model for integrated plan and evaluation of distributed energy systems," *Appl. Energy*, vol. 87, no. 3, pp. 1001–1014, 2010.

## **CHAPTER 7. ALUMNI NETWORK**



# Flensburg Association for Energy Management - Nepal (FAEM –Nepal): The Past, Present and Future

Dr. tan P. Chaulagain

Flensburg Association for Energy Management – Nepal

Email: [narayanchaulagain@gmail.com](mailto:narayanchaulagain@gmail.com)

## Abstract

Flensburg Association for Energy Management Nepal is an association of Nepalese alumni of the University of Flensburg, Germany established in 2004. It is registered as a non-governmental organization under the Association Registration Act of Nepal. Currently, it has 41 members in it. It is an independent, service oriented institution established to bring both former and current Nepalese students from the German university together under one umbrella to work towards sustainable energy management solutions. It also closely coordinates with Nepalese alumni associations of other German universities for sectoral development. The members of this organization hold important positions in the Nepalese government institutions; international development organization like Asian Development Banks, United Nations Development Programme, German Development Cooperation –GIZ; international non-governmental organizations; national/international consulting companies; universities and academic institutions; renewable energy industries; construction and manufacturing sector etc. Its members are playing a prominent role in energy and environment planning and sustainable development of Nepal.

**Key Words:** *Flensburg, Appropriate rural technology, Energy and environment management, Sustainable energy systems, Nepalese alumni of German universities*

## 1 Background

The first Nepalese graduates of the University of Flensburg were from the Appropriate Rural Technology and Extension of Skills (ARTES) of the University in the year 1996. The alumni organization as a non-profit was registered in 2004 by when there were already 15 graduates to establish as a common forum of all the graduates. The objectives of the alumni organization, which was named as Flensburg Association for Energy Management Nepal (FAEM Nepal) are as follows:

- Initiate, improve and strengthen networking, understanding, support and solidarity among Nepalese students who have studied at Flensburg University
- Establish a continuous institutional relationship with Flensburg University and other universities offering graduate and postgraduate courses in renewable energy and sustainable development in Germany.
- Establish contacts, exchange information, experiences and knowledge with similar alumni associations in other countries.
- Advocate/lobby for energy access to all on right-based approach.

There was long discussion and creative debate before we came to the conclusion of naming it as it was accepted. The alumni members involved during its establishment agreed on the following principles while naming it:

- Identity of Flensburg
- Energy management, which was the main focus at that time
- Thinking that similar alumni institutions could be formed in other countries with the same name ,e.g. FAEM India, FAEM Indonesia, FAEM Bangladesh etc. as well as FAEM International. FAEM Nepal was the first alumni organization of its kind of the University of Flensburg by then.

Ultimately, it was agreed to name the alumni organization as Flensburg Association for Energy Management Nepal (FAEM Nepal) and registered at the Office of District Administration Kathmandu as per the Association Registration Act of Nepal in 2004.

## 2 Current Status

Currently, there are 41 members in the organization. The first ones graduated in 1996. The highest number was 5 in 2004 and there was none in 1997 and 1998 (see Fig 1) . Otherwise, there is a regular increase in the number of alumni.

- FAEM-Nepal is also an institutional member of the German Asian Alumni Network for Energy and Sustainability (GANES) registered in India as a charitable trust.
- FAEM- Nepal is an founding institutional member of German Alumni Association in Nepal (GAAN) , an umbrella organization of all German alumni in Nepal.

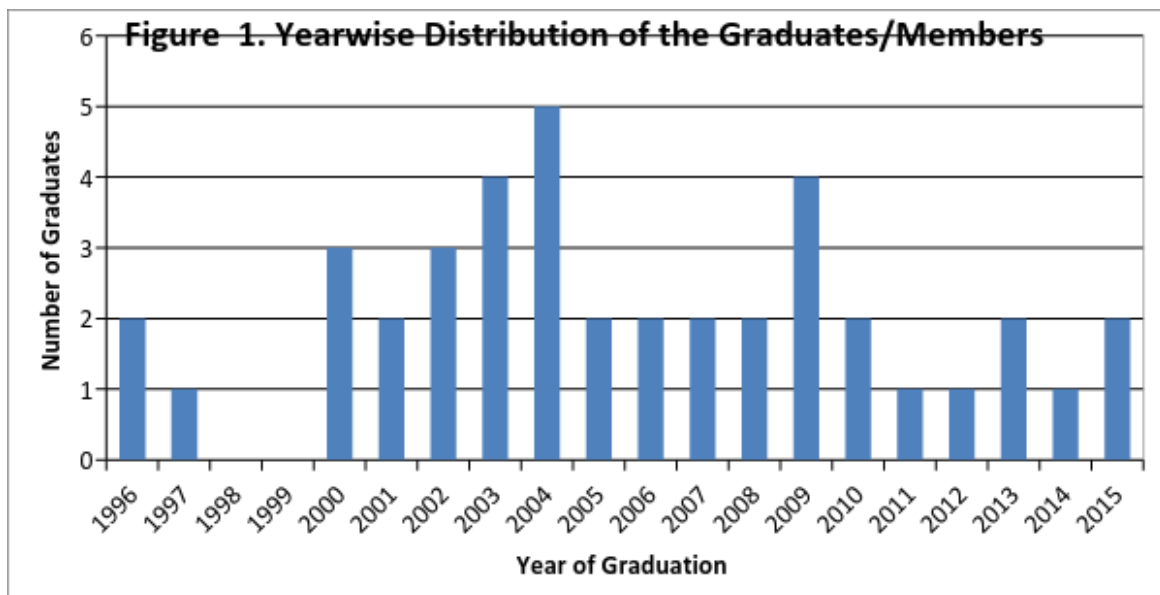

The alumni members consist of the graduates of 3 different study programmes of the University of Flensburg, viz. Appropriate Rural Technology and Extension of Skills (ARTES), Sustainable Energy Systems and Management (SESAM) and Energy and Environment Management (EEM). The majority of the existing membership base is made from SESAM stream (see Fig 2).

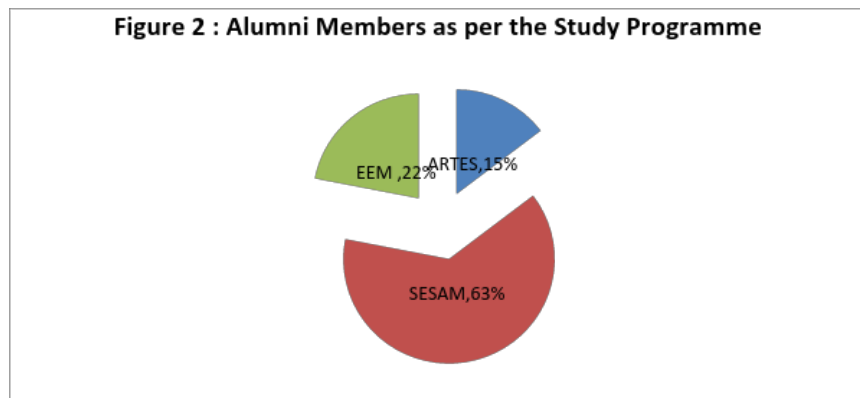

### 3 Field of Activities of FAEM Nepal

FAEM Nepal has been providing expert services to national and international governmental and non-governmental organizations in the field of energy planning and management; energy governance; rational use of energy; energy efficiency; energy audit; energy and climate change. Some of the exemplary activities which FAEM Nepal can carry out are as followings:

- Conduct studies in the fields of renewable energy, energy efficiency and environment management
- Publish reports, bulletins and sensitization materials.
- Organize workshops, seminars orientations and trainings on renewable energy and sustainable development.
- Provide consultancy services to individuals, institutions and agencies on different aspects of renewable energy technologies, energy efficiency and sustainable development such as energy development and management, human resource development, environment management, planning and policy making.
- Provide counseling services to Nepalese students seeking higher education in Germany particularly at the University of Flensburg.
- Facilitate transfer of knowledge and technology related to renewable energy systems and management between north and south.

#### 3.1 Past Alumni Events organized by FAEM Nepal

FAEM Nepal has so far successfully organized three alumni events jointly with the University of Flensburg through the financial support from DAAD as follows:

##### ***3.1.1 National Seminar on the Role of Renewable Energy and Sustainable Development Agenda of Nepal***

The 3-day seminar was conducted in Kathmandu in May 2004. The main objective of the seminar was to create linkages between renewable energy promotion and sustainable

development. The event was attended by representatives from Flensburg University, its alumni in Nepal and national/international stakeholders in renewable energy and sustainable development sectors from Nepal. The seminar also focused on highlighting the “Sustainable Development Agenda for Nepal (SDAN)” formulated by the Government of Nepal. Important interactions were held on how the alumni of Flensburg University could play a contributing role in achieving the sustainable development agenda of Nepal.

### ***3.1.2 South Asian Regional Seminar on Renewable Energy for Sustainable Development***

This 5-day seminar was held in Kathmandu and Pokhara in May 2008. The Flensburg University alumni from both South Asia and Asia Pacific regions participated in the seminar. Similarly, renewable energy experts from different national and international agencies working in Nepal also participated in the workshop. The main aim of the seminar was to enhance networking between Flensburg University alumni working in the renewable energy and environment sector in the region. The main part of the financial support for the program was contributed by DAAD. The findings of the workshop were fruitful for academicians and development practitioners in Nepal as well as abroad. This seminar was also productive to further strengthen the alumni network with Flensburg University.

### ***3.1.3 International Workshop on Scaling Up Renewable Energy towards Reducing Climate Change Impacts***

The 4-day event was held in Kathmandu and Nagarkot in October 2013. The main objectives of the workshop were to exchange knowledge and ideas on successful initiatives of renewable energy promotion with linkages towards reducing climate change impacts among the participants, and to enhance networking and cooperation for future collaborations. This event was attended by 39 alumni members and representatives from Flensburg University (i.e. 22 international alumni from 14 different countries (Argentina, Bangladesh, Cameroon, China, Ghana, India, Indonesia, Kenya, Mexico, The Philippines, Swaziland, Thailand, Uganda and Vietnam) as well as 20 national alumni from Nepal along with 3 participants from Flensburg University). The workshop also encouraged establishment of Global Network of Alumni of Flensburg University as well as possible collaboration and cooperation among global alumni. The event has also helped in promoting South-South collaboration and cooperation among the alumni members.

## **3.2 Other Projects Conducted**

Besides the alumni events organized jointly with the University of Flensburg, FAEM Nepal has accomplished a number of projects for the national and international development organizations. Some of the accomplished projects are as follows:

- A study on socio economic feasibility study for end use diversification in IWM and integration of other income generating activities around IWM sites (2005)
- A study on potential of using electricity for shallow tube well irrigation in Terai (2005)
- Orientation training to district level NGOs (2006)
- Quality verification of IWM as precondition of release of outstanding 10% subsidy for all established sites( In 2006, 2007 and 2008)

- Establishment of wind power pilot project in Pyuthan (2007)
- Lessons learnt and experience of REGDAN: Possible ways for further mutual cooperation between private and public sector (2007)
- Preparation of District Energy Perspective Plan of Chitwan District (2010)

#### **4 Issues and Challenges**

Most of the FAEM Nepal members are full-time employed and find difficulties for alumni activities. Mostly, they are in senior positions and have greater responsibilities than being involved in alumni activities. As a non-profit organization, it is rather difficult to financially survive just on membership fee. Likewise, it is more difficult to those FAEM Nepal members, who are living outside of capital city of Kathmandu. Out of the total members, 11 members are currently living outside of Nepal and greater difficulties in participating in day-to-day activities. More alumni activities leading to the better recognition inside and outside of Nepal of the FAEM Nepal may attract alumni members into FAEM Nepal activities.

#### **5 Way Forward: Future Direction of FAEM Nepal**

FAEM Nepal is willing to carry its face as a team of highly qualified alumni experts of Flensburg University. At the same time it is willing to collaborate and even be united with other Nepalese alumni of the German Universities who pursued sustainable energy and environment related higher education remaining within the Nepalese legal framework. More alumni events need to be organized leading to enhanced expert contributions to Nepal's sustainable energy development and environment management in order to motivate the alumni members for increasing their contributions to the alumni activities.